



support.keycafe.com

Scan to watch
installation video

Scannez pour regarder
la vidéo d'installation

スキャンして、設置案内動画
を確認しましょう



keycafe.com/ml/ms5

MS5

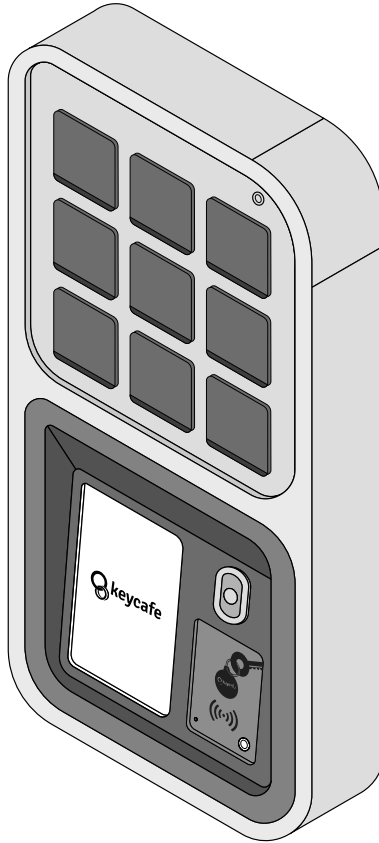

ENGLISH

STOP - Do not install until you have read the instructions.

FRANÇAIS

ATTENTION - N'installez pas tant que vous n'avez pas lu les instructions.

日本語

注意 - こちらの説明書に目を通してから設置してください

English.....	3
Français.....	11
日本語.....	19

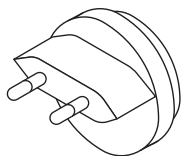

x1 A

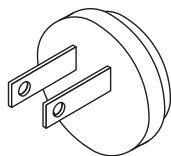

x1 A

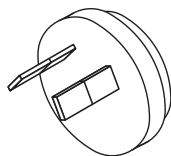

x1 A

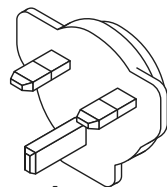

x1 A

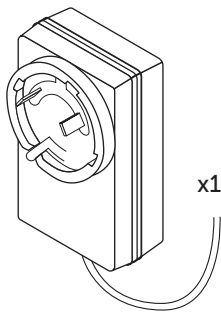

x1 B

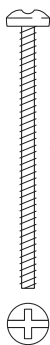

C
x7

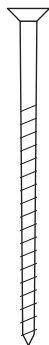

D
x5

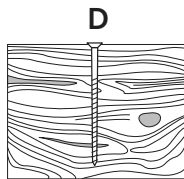

D

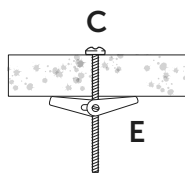

C

E

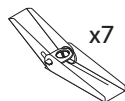

x7 E

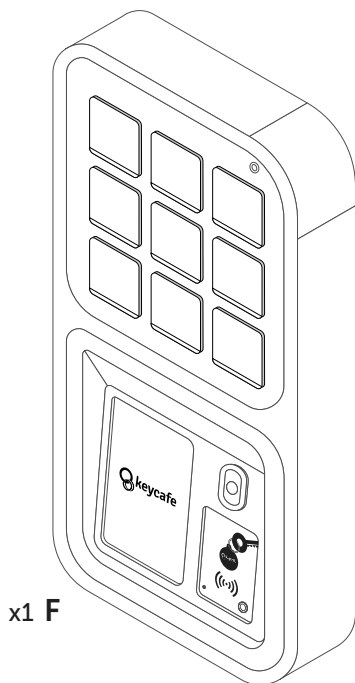

x1 F

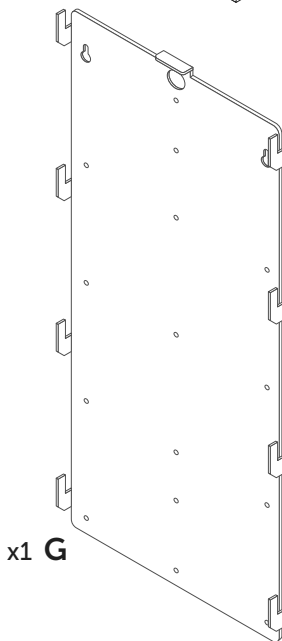

x1 G

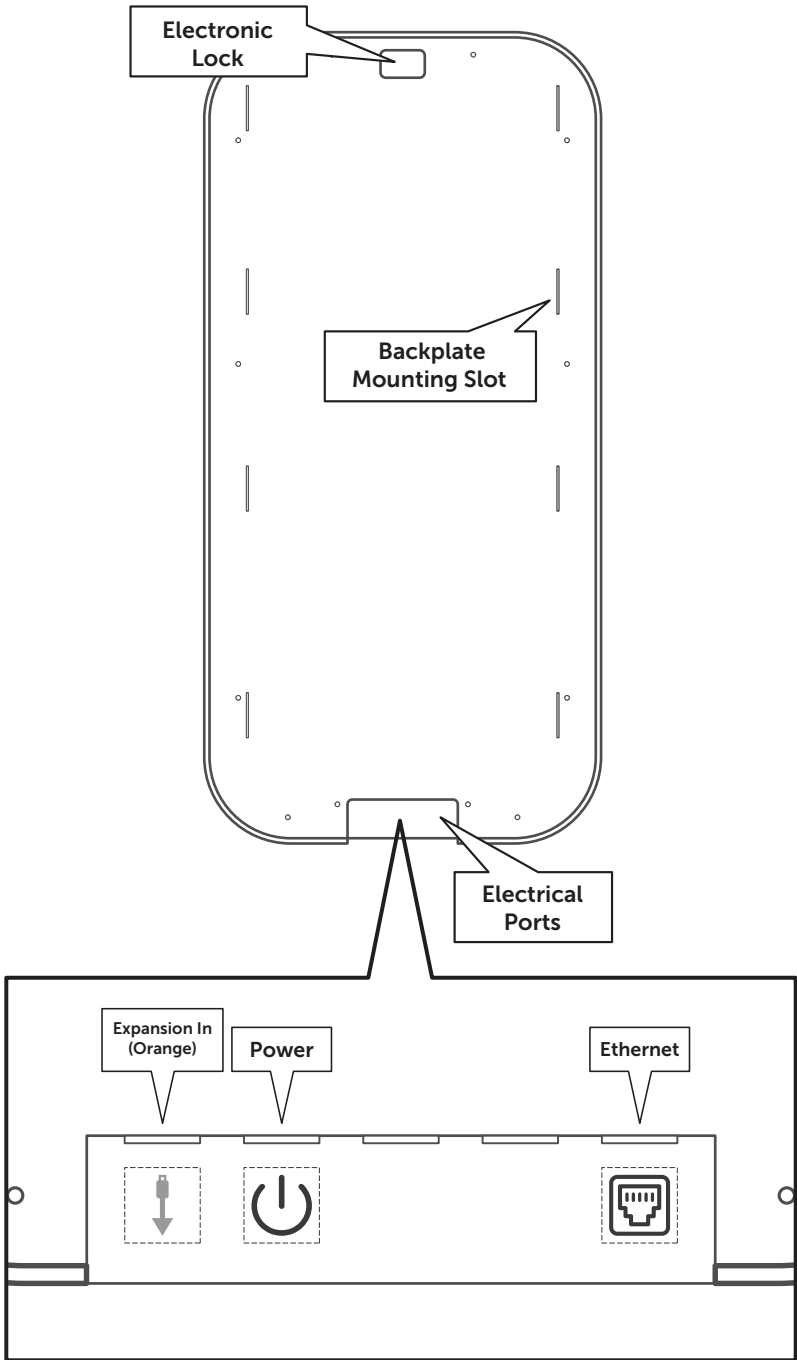

1.

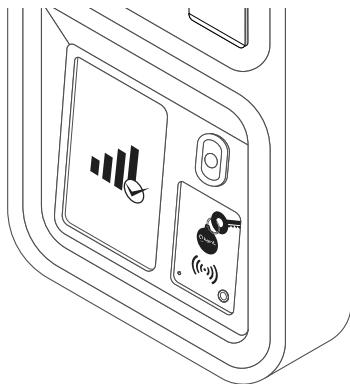

F

IMPORTANT: Ensure the SmartBox is connected to Wifi or Ethernet before mounting to the backplate (**minimum 20% signal**).



Follow the on-screen instructions for WiFi setup or scan to watch video.

keycafe.com/ml/ms5_wifi

2.

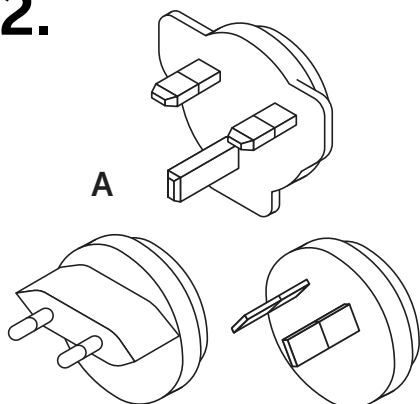

A

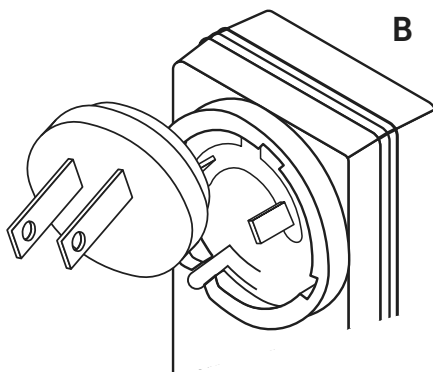

B

3.

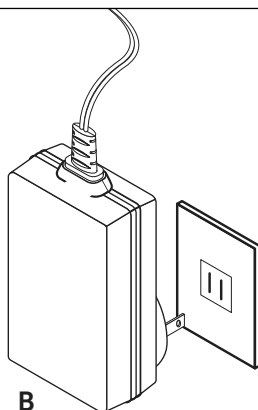

B

4. ADD SMARTBOX TO ACCOUNT



Scan to watch video

keycafe.com/ml/add_smartbox

5. TEST THE SMARTBOX



Scan to watch video

keycafe.com/ml/test_smartbox

Placement Considerations

When installing your MS5 SmartBox, there are six major placement considerations that will ensure you get the optimal performance and longevity out of your system.



Safety

The SmartBox must be installed with screws onto wooden studs minimum size 2" x 4" (5cm x 10 cm) or concrete block minimum thickness 8" (20cm). Ensure the power outlet, environment and installation approach meets all requirements and standards in accordance with documentation available at www.keycafe.com as well as local laws, regulations and guidelines related to fixed installations. Always install with 2 people to prevent dropping the SmartBox with cables attached.



Power

The SmartBox requires a standard power outlet (110v or 220v) and includes universal adapters. The power safety rating does not cover hard wired installations. Only use the supplied 12v power adapter.



Security

Install in a well-lit, surveilled area to reduce the risk of theft or vandalism. The Keycafe SmartBox is a convenient way to manage key access and can be damaged or broken into if left unattended in unsecured areas.



Connectivity

Prior to mounting the SmartBox on the backplate, turn on the SmartBox in the exact location it will be mounted, and follow the instructions to connect the system to WiFi. Once connected, view the device status on the SmartBox screen to ensure there is enough signal before proceeding to mount the backplate. We **STRONGLY RECOMMEND** installing the device in a location with at least a 20% or more cellular signal or 50% or more WiFi signal.



Accessibility

The installation area should consider all users of the SmartBox so they can reach all bins, the scanner and keypad, as well as continued accessibility of pathways and halls the SmartBox is installed into. We recommend at a minimum adhering to US ADA guidelines which recommend the max height of the top of the SmartBox to be 48" (122cm) from the floor and a minimum of 48" (75cm) of obstruction-free space in front, but you should also check any local regulations or guidelines that may be applicable to your installation. Learn more about the ADA guidelines at www.keycafe.com/ml/accessibility



Expandability

If you have purchased expansion units or plan to in the future, keep in mind the space required for them. Each MS5E-18 requires a min of 11.4" x 23.3" (29cm x 59cm) area to install. Each MS5E-42 requires a min of 23.8" x 23.3" (60.5cm x 59cm). You can mount expansions on either side of the base station.

6.

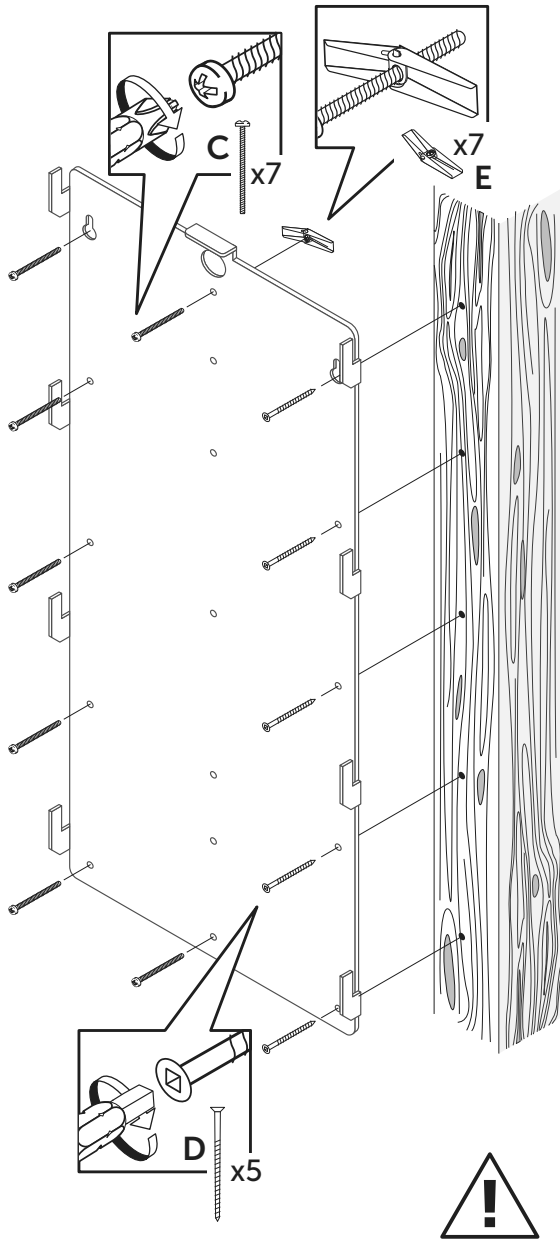

Important: Line up one row of holes along a stud in the wall and use the D screw.

7.

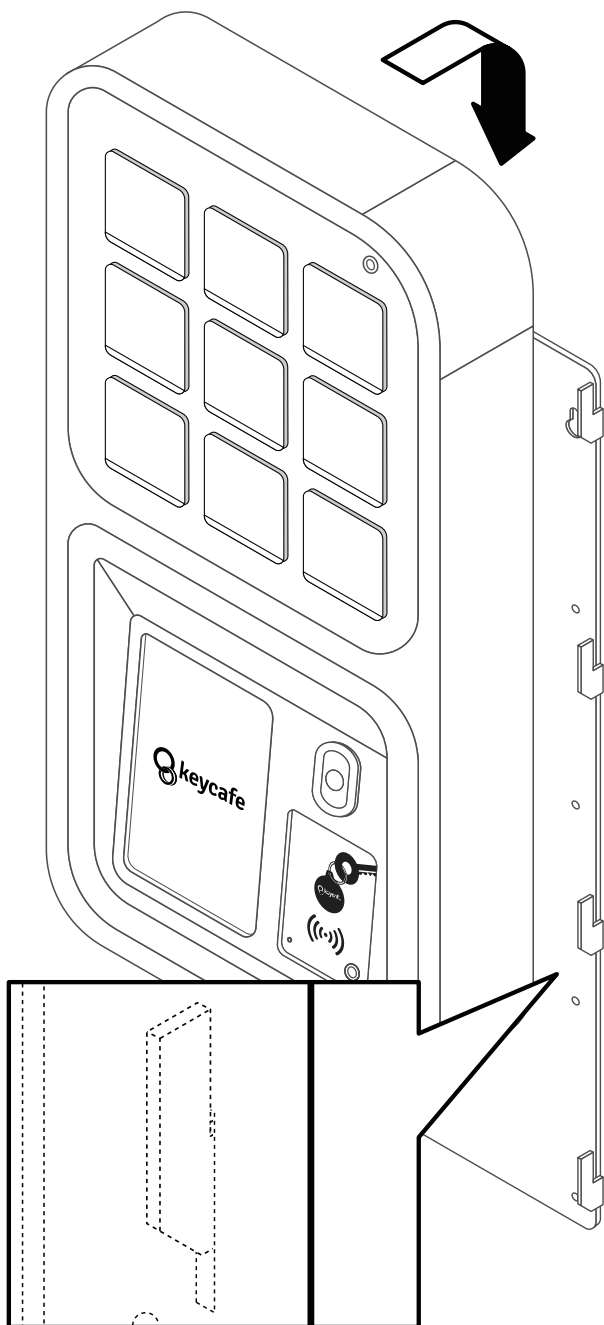

8.

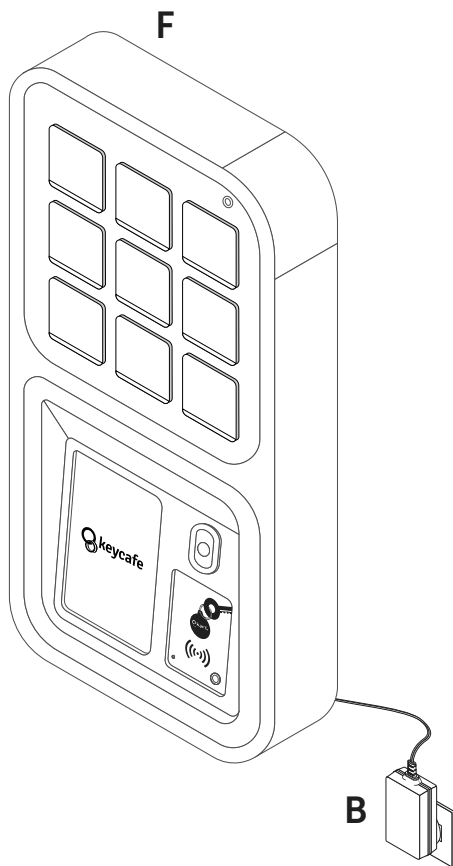

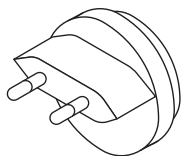

x1 A

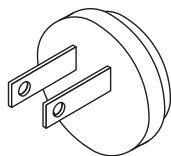

x1 A

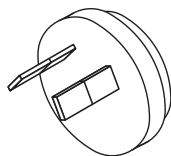

x1 A

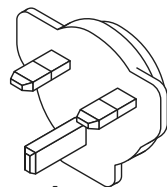

x1 A

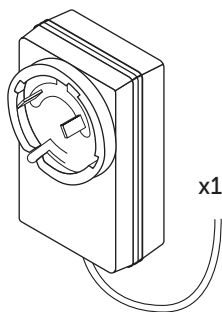

x1 B

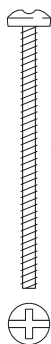

C

x7



D

x5

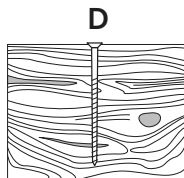

D

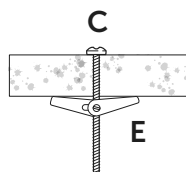

C

E

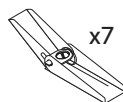

x7 E

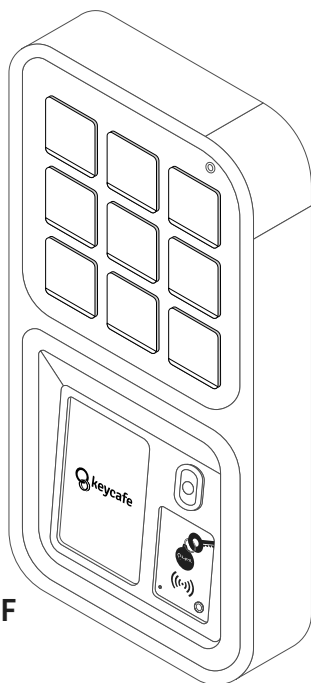

x1 F

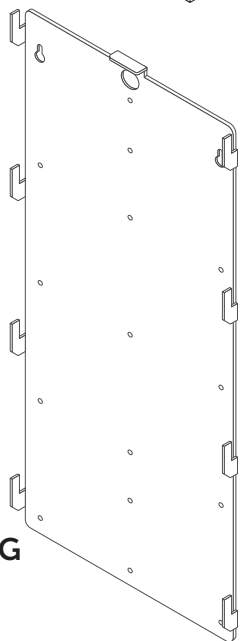

x1 G

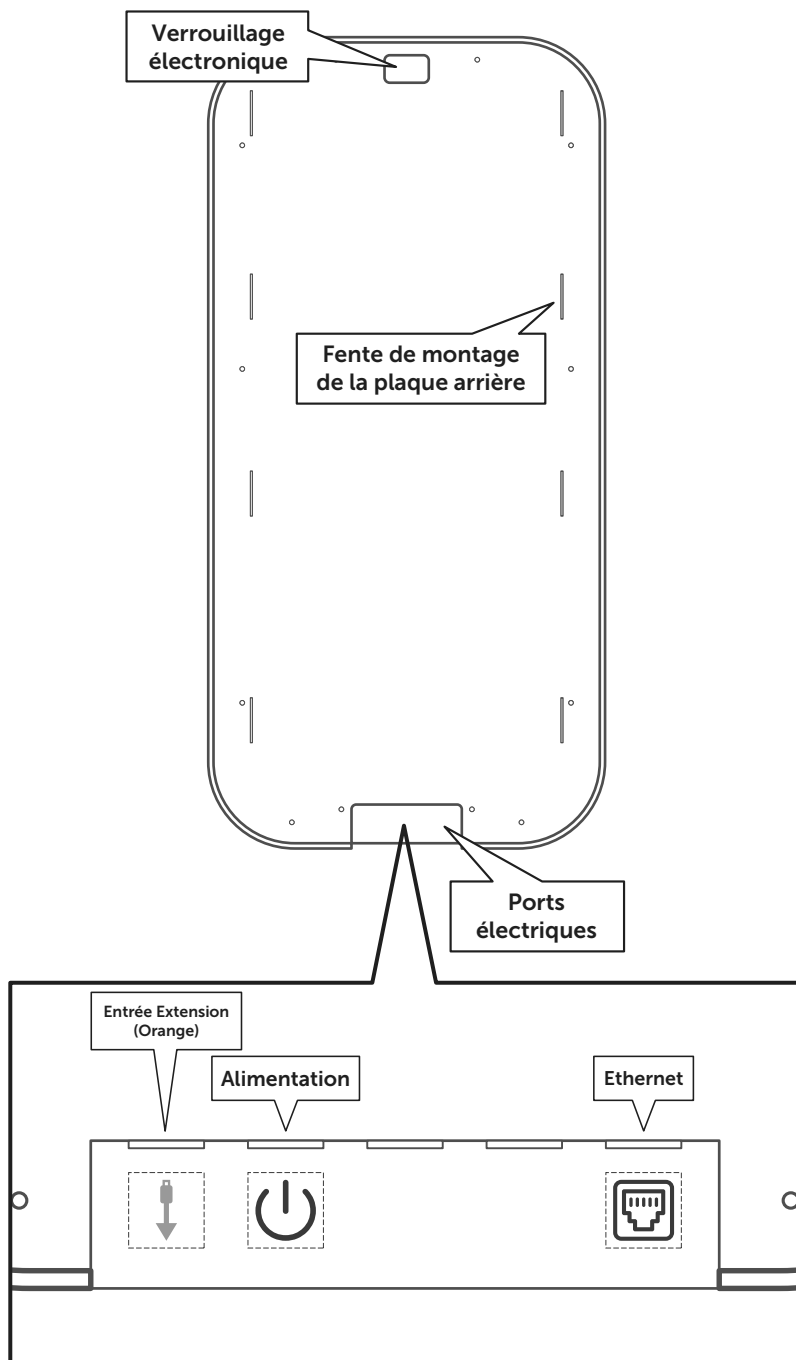

1.

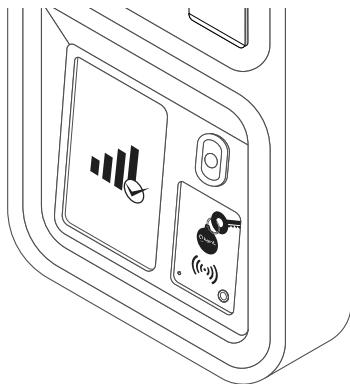

IMPORTANT: Assurez-vous que la SmartBox est connectée au WiFi ou Ethernet avant de la monter sur la plaque arrière (**signal minimum de 20%**).



Suivez les instructions à l'écran pour configurer le Wi-Fi ou scannez pour regarder la vidéo.

keycafe.com/ml/ms5_wifi

2.

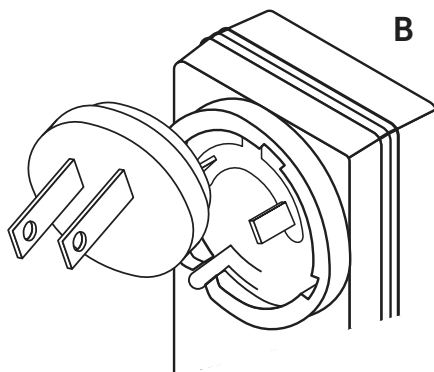
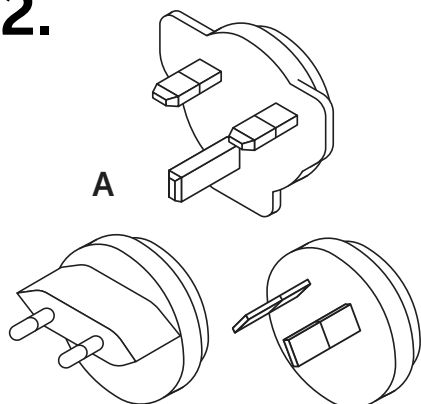

3.

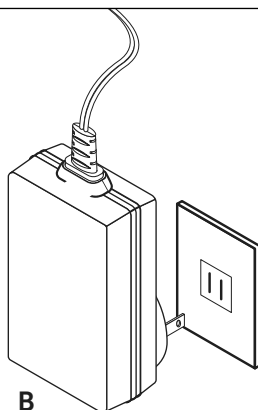

4. AJOUTER LA SMARTBOX AU COMPTE



Scannez pour regarder la vidéo

keycafe.com/ml/add_smartbox

5. TESTER LA SMARTBOX



Scannez pour regarder la vidéo

keycafe.com/ml/test_smartbox

Considérations relatives à l'emplacement

Lors de l'installation de votre SmartBox MS5, il y a six considérations de placement majeures qui vous assureront d'obtenir les performances et la longévité optimales de votre système.



Sécurité

La SmartBox doit être installée avec des vis sur des montants en bois de taille minimum 2" x 4" (5 cm x 10 cm) ou un bloc de béton d'une épaisseur minimum de 8" (20 cm). Assurez-vous que la prise de courant, l'environnement et l'approche d'installation répondent à toutes les exigences et normes conformément à la documentation disponible sur www.keycafe.com ainsi qu'aux lois, réglementations et directives locales relatives aux installations fixes. Assurez-vous d'installer à 2 personnes pour éviter que la SmartBox tombe avec les câbles attachés.



Alimentation

La SmartBox nécessite une prise de courant standard (110V ou 220V) et comprend des adaptateurs universels. La cote de sécurité de l'alimentation ne couvre pas les installations câblées. Utilisez uniquement l'adaptateur secteur 12V fourni.



Sûreté

Installez dans un endroit bien éclairé et surveillé pour réduire les risques de vol ou de vandalisme. La SmartBox Keycafe est un moyen pratique de gérer l'accès aux clés et peut être endommagée ou cassée si elle est laissée sans surveillance dans des zones non sécurisées.



Connectivité

Avant de monter la SmartBox sur la plaque arrière, allumez-la à l'endroit exact où elle sera montée et suivez les instructions pour connecter le système au WiFi ou au cellulaire. Une fois connecté, affichez l'état de l'appareil sur l'écran de la SmartBox pour vous assurer qu'il y a suffisamment de signal avant de procéder au montage de la plaque arrière. Nous RECOMMANDONS FORTEMENT d'installer l'appareil dans un endroit avec au moins 20 % ou plus de signal cellulaire ou 50 % ou plus de signal wifi.



Accessibilité

La zone d'installation doit tenir compte de tous les utilisateurs de la SmartBox afin qu'ils puissent atteindre tous les casiers, le scanner et le clavier, ainsi que l'accessibilité continue des chemins et des halls dans lesquels la SmartBox est installée. Nous vous recommandons d'adhérer au minimum aux directives de l'US ADA qui recommandent que la hauteur maximale du haut de la SmartBox soit de 48" (122 cm) du sol et un minimum de 48" (75 cm) d'espace libre devant, mais vous devriez également vérifier toutes les réglementations ou directives locales qui peuvent être applicables à votre installation. En savoir plus sur les directives de l'ADA sur (www.keycafe.com/ml/accessibility).



Extensibilité

Si vous avez acheté des unités d'extension ou prévoyez de le faire à l'avenir, gardez à l'esprit l'espace requis pour celles-ci. Chaque MS5E-18 nécessite une superficie minimale de 29cm x 59cm pour l'installer. Chaque MS5E-42 nécessite une superficie minimale de 60.5cm x 59cm pour l'installer. Vous pouvez monter des extensions de chaque côté de la station de base.

6.

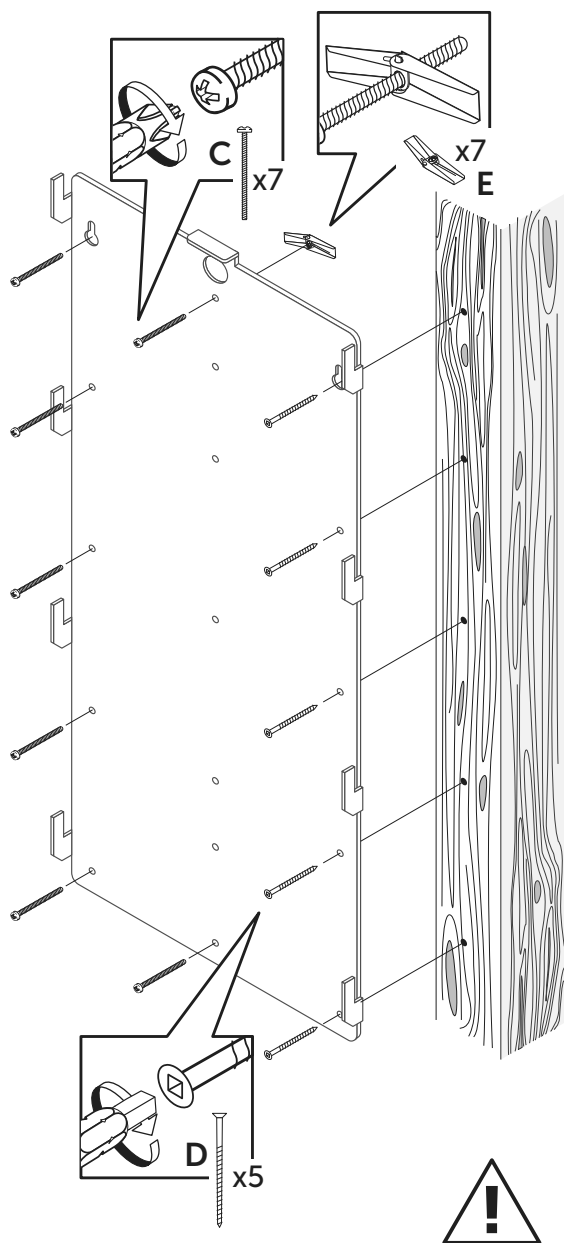

IMPORTANT: Alignez une rangée de trous le long d'un montant dans le mur et utilisez la vis D.

7.

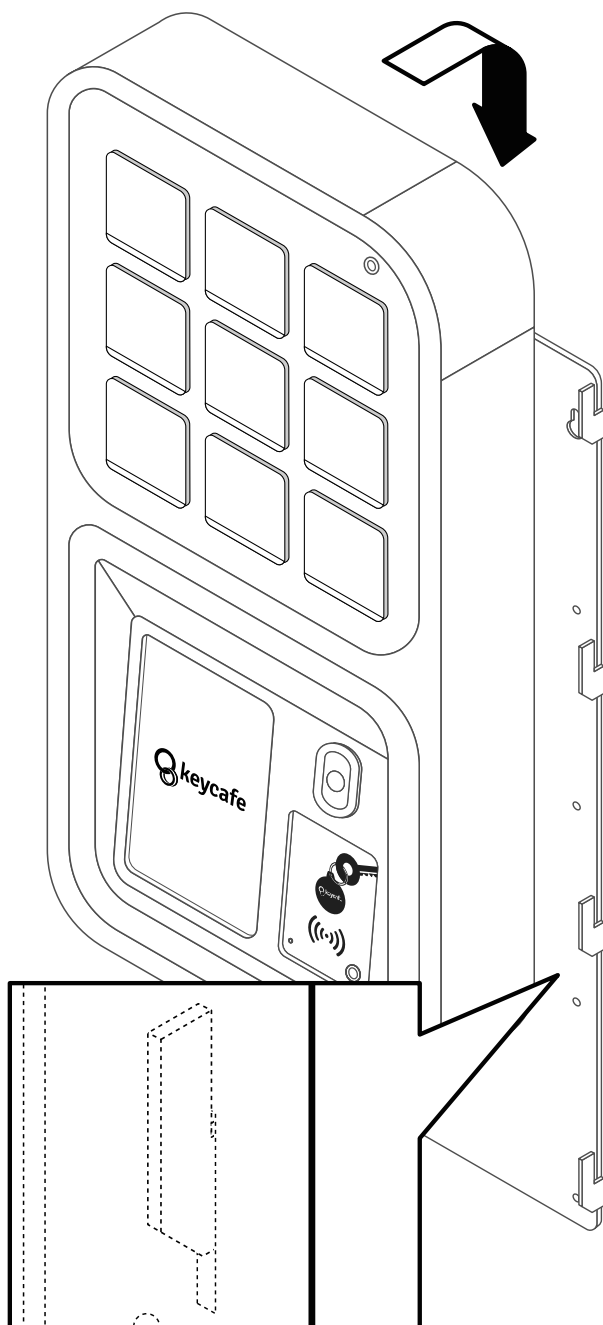

8.

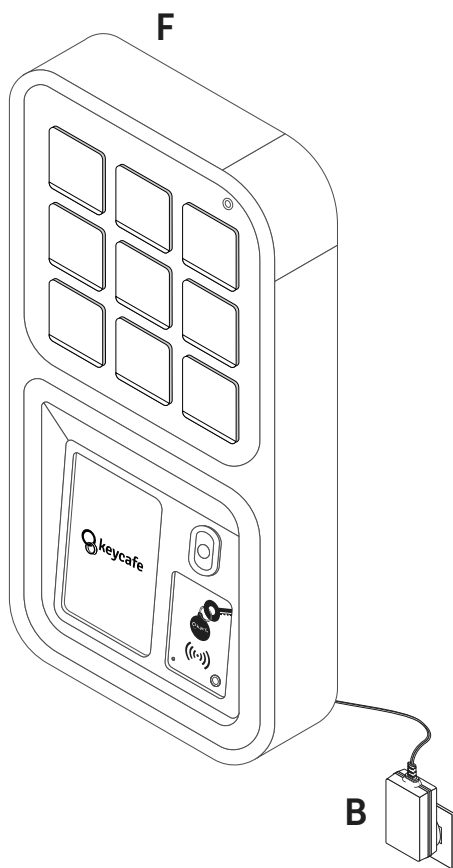

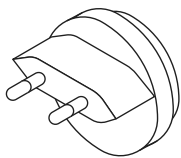

x1 A

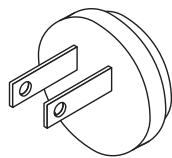

x1 A

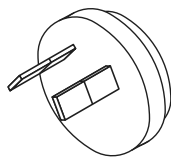

x1 A

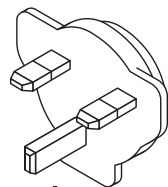

x1 A

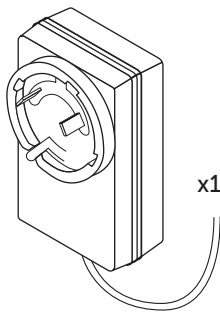

x1 B

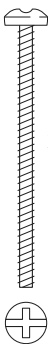

C
x7

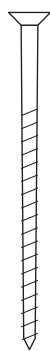

D
x5

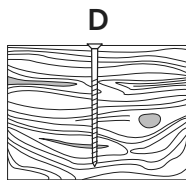

D

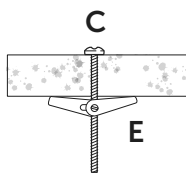

C

E

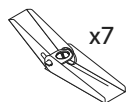

x7 E

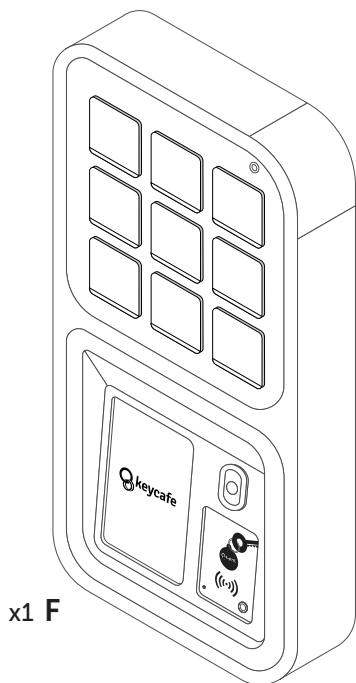

x1 F

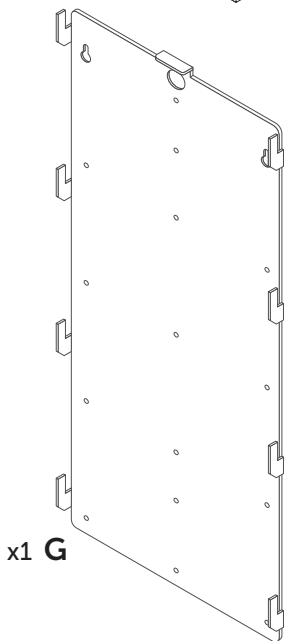

x1 G

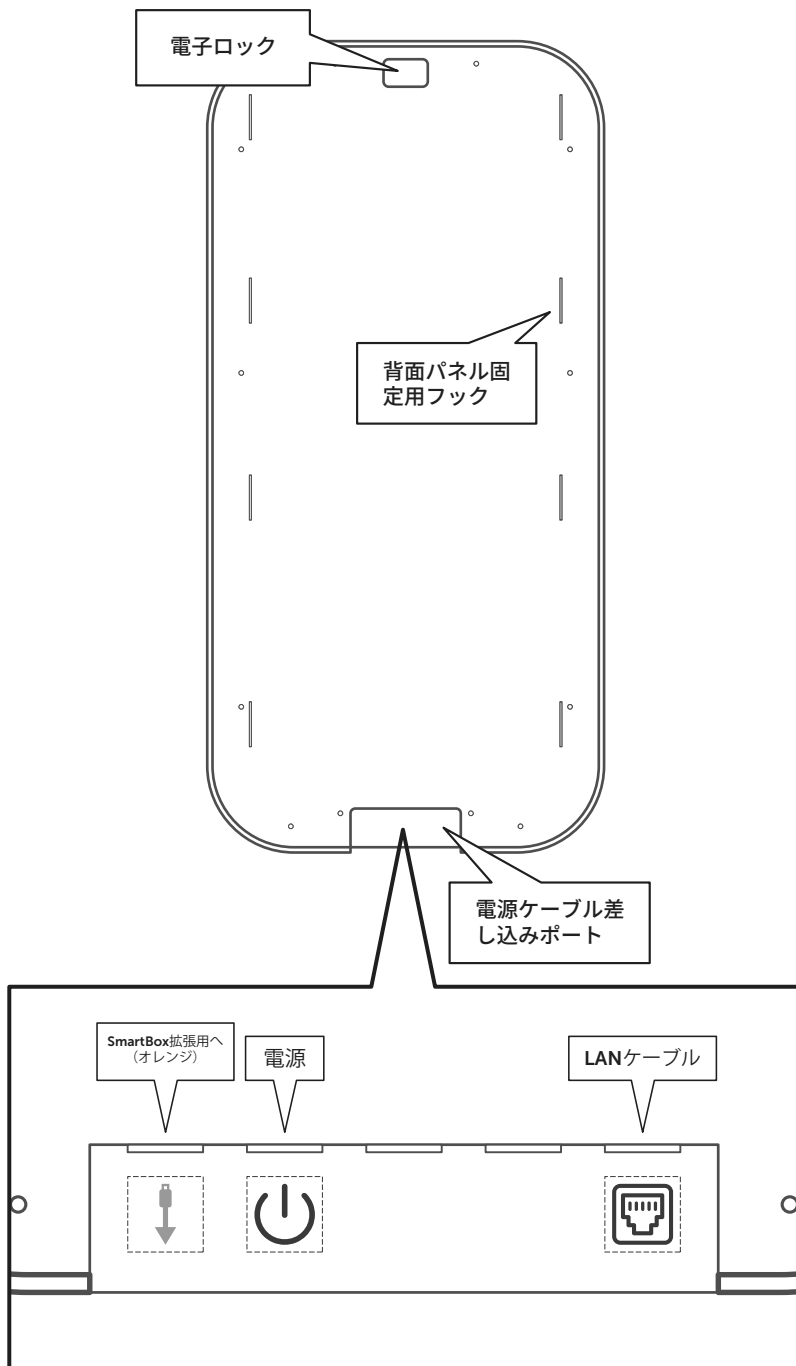

1.

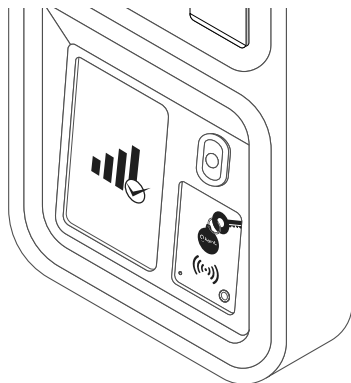

F

重要: パックパネル取り付け前に、必ずWiFiまたはLANケーブルでSmartBoxがオンライン(最低限20%の電波受信)になっていることを確認してください。



タッチパネルの表示に沿ってWiFi設定に進むか、QRコードをスキャンして動画を閲覧してください

keycafe.com/ml/ms5_wifi

2.

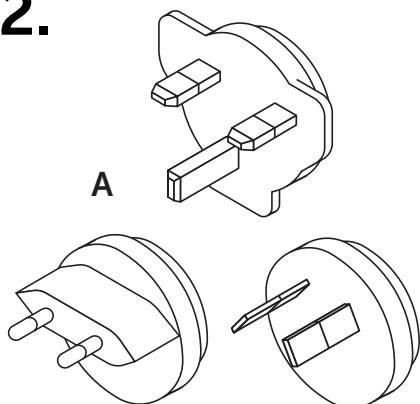

A

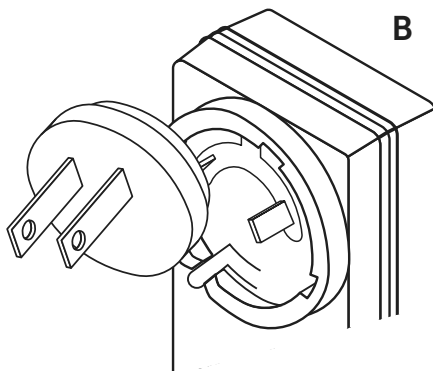

B

3.

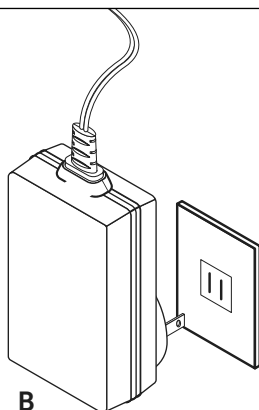

B

4. SMARTBOXをKEYCAFEアカウントにリンクする



スキャンして動画を見る

keycafe.com/ml/add_smartbox

5. SMARTBOXの作動確認



スキャンして動画を見る

keycafe.com/ml/test_smartbox

設置の注意点

MS5 SmartBoxを設置するには、以下6つの注意点を考慮してください



安全

SmartBoxは5cm x 10cm 以上の木製下地、または20cm以上の厚さのコンクリートにビス留めで設置してください。電源、その他設置環境・設置方法が、www.keycafe.comに記載の必要条件と、設置場所における法律、条例に順することをご確認ください。設置の際にSmartBoxを落とさないよう、2名での作業をお勧めします。



電源

一般的な電源(100v-220v) が必要です。付属のアダプター以外は利用しないでください。



セキュリティ

盗難・破壊を避ける為、明るく、監視可能な場所に設置してください。Keycafeは利便性の高い鍵管理サービスですが、治安の悪い場所に放置されると壊される可能性もございます。



接続

SmartBoxを設置する前に、設置予定場所に置いて、手順に沿ってWiFiまたはSIMでオンライン接続してください。オンライン接続後に、「デバイスの状態」から十分な電波が受信されていることを確認します。SIMで20%以上、WiFiは50%以上の電波受信状況での設置を推奨します。



アクセシビリティ

SmartBoxの全ての鍵キャビネット、スキャナとタッチパネルが利用できる環境に設置してください。鍵の受け渡しが必要な時間帯に、利用者がアクセスできることも必要です。Keycafeはアメリカ障害者法 (ADA) ガイドラインの遵守を奨励しています。SmartBoxの上部が地面から122cmまで、SmartBoxの前に最低限75cmの障害物の無いスペースを確保することが推奨されます。



拡張用端末

Smartboxの拡張用端末をご購入のお客様へ：①設置スペースはMS5E-18が29cm x 59cmのスペースが必要です。MS5E-42の場合 60.5cm x 59cm。②拡張用端末は本体の左側、右側どちらでも設置可能です。

6.

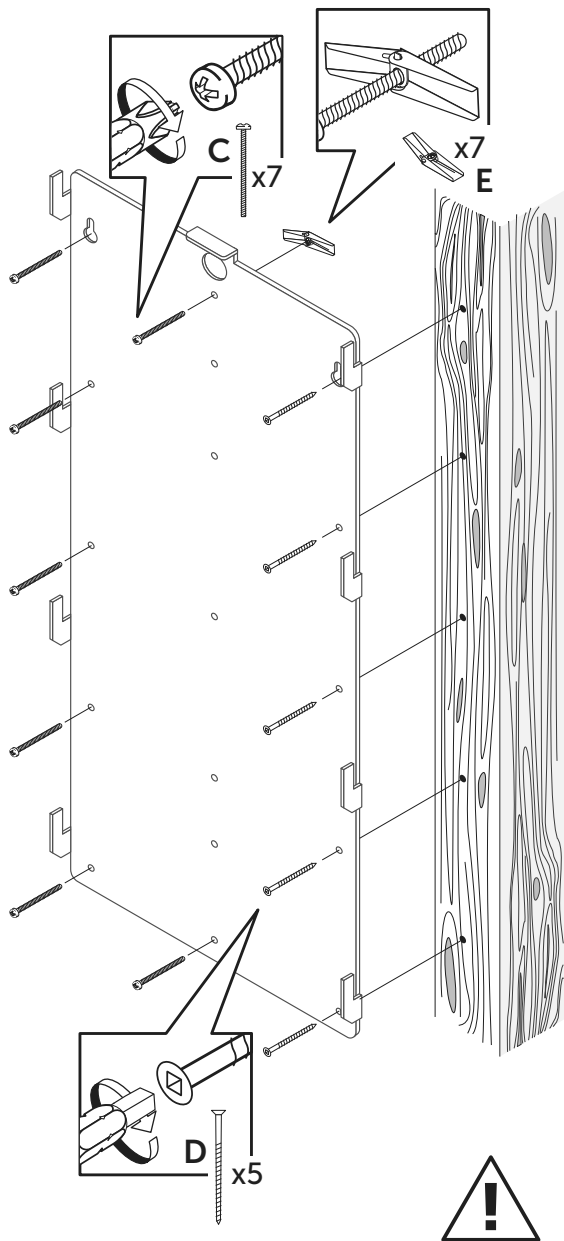

重要:下地のある壁にビスを打ち込んでください

7.

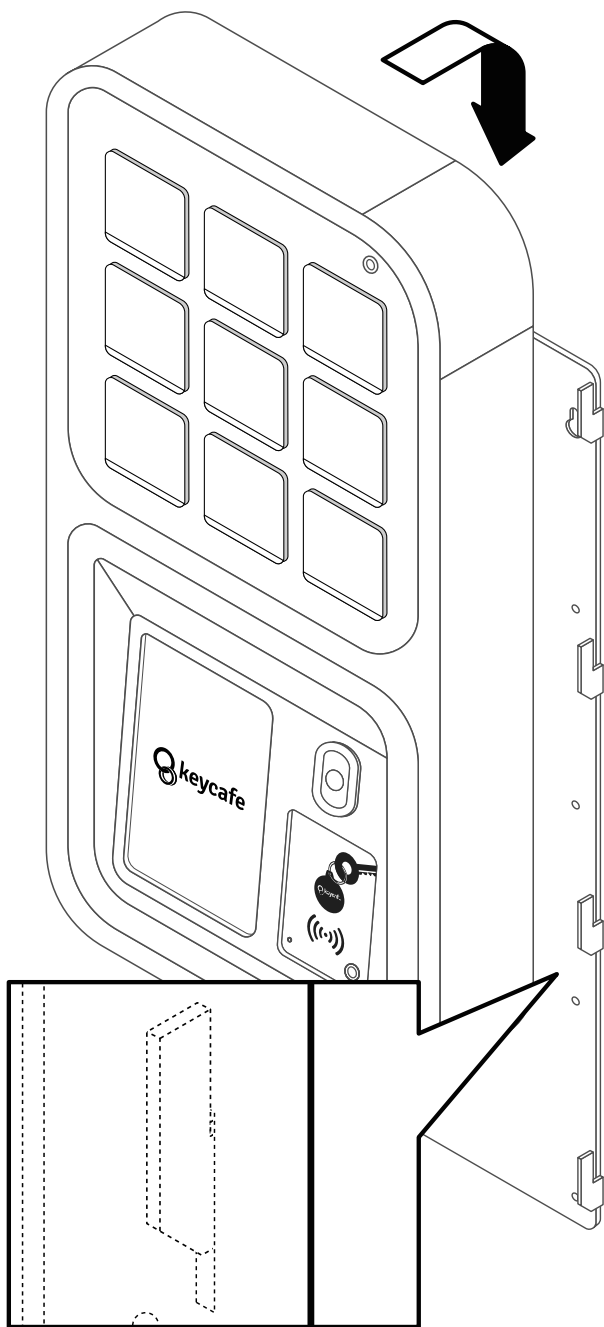

8.

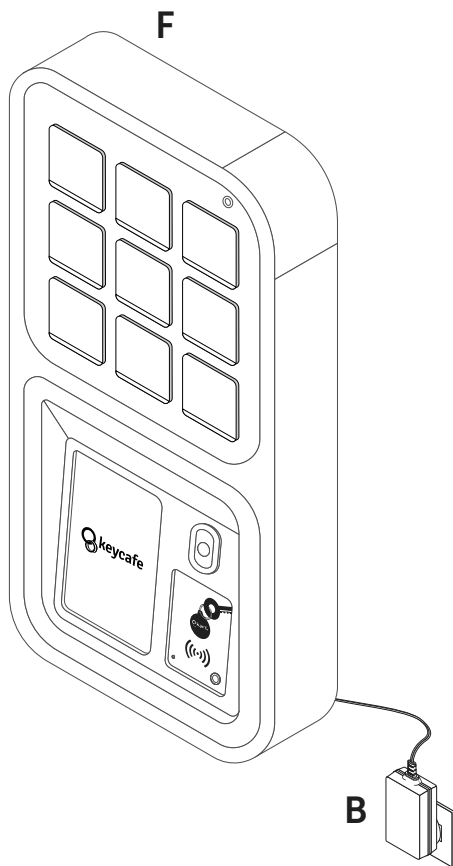



Visit our Help Centre:
Visitez notre Centre d'Aide:
Keycafeヘルプセンター:
support.keycafe.com

Talk to us on live chat:
Parlez-nous sur le chat en direct:
Keycafeカスタマーサポート:
keycafe.com/help