

MS3E

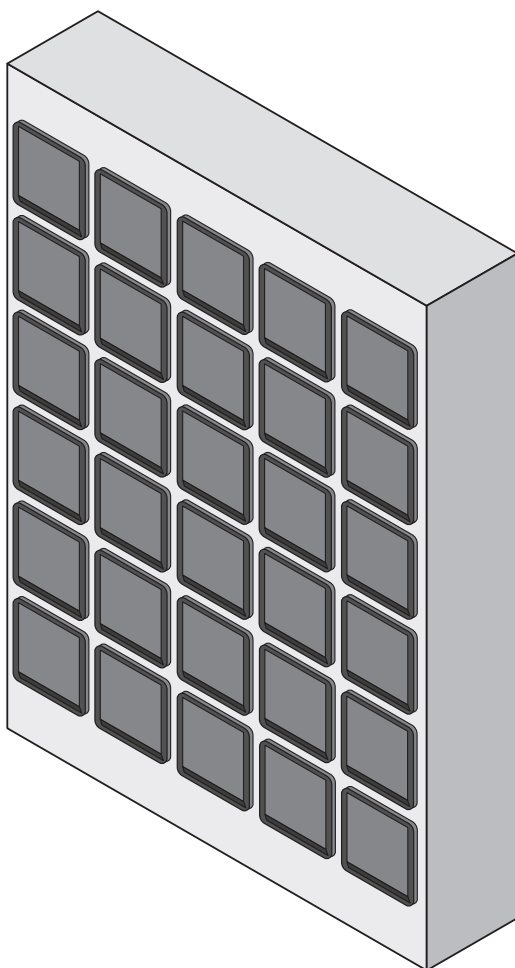

ENGLISH

STOP - Do not install until you have read the instructions.

FRANÇAIS

ATTENTION - N'installez pas tant que vous n'avez pas lu les instructions.

日本語

注意 - こちらの説明書に目を通してから設置してください

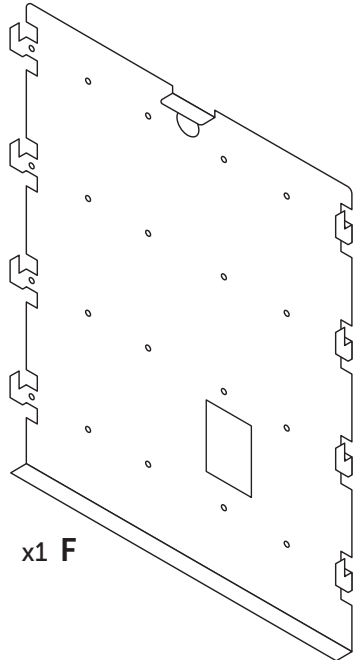
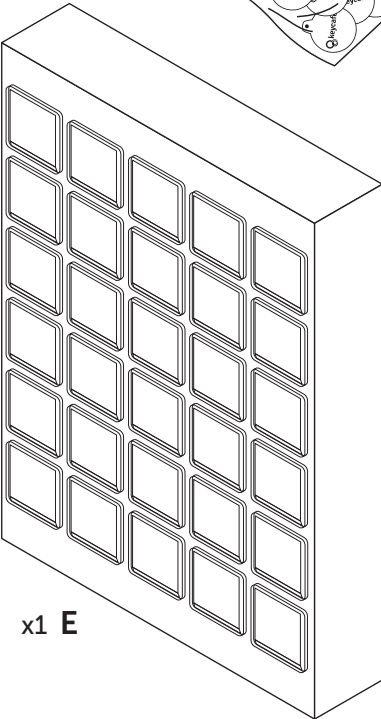
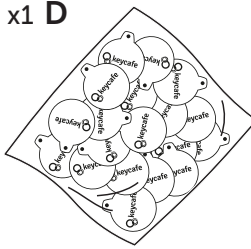
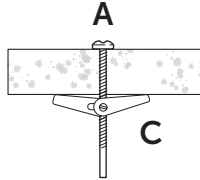
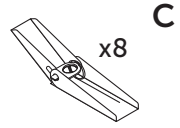
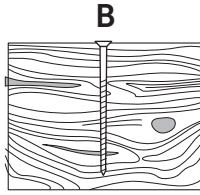
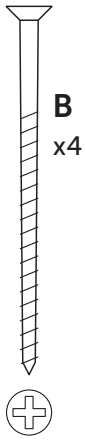
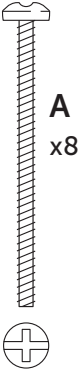

**HEAVY. 25LBS (12KG)**

IMPORTANT: 2 people required for installation. Ensure that each SmartBox is held to avoid tension on the ethernet cable to prevent system damage.

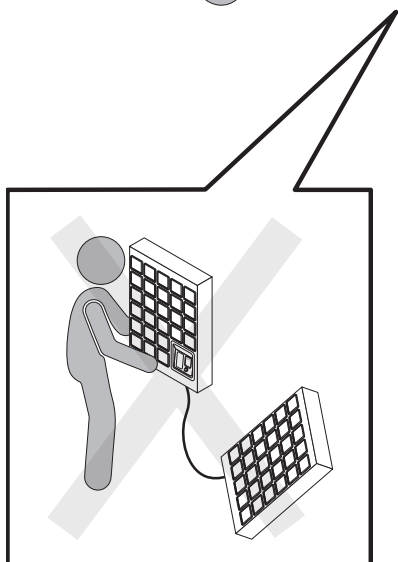
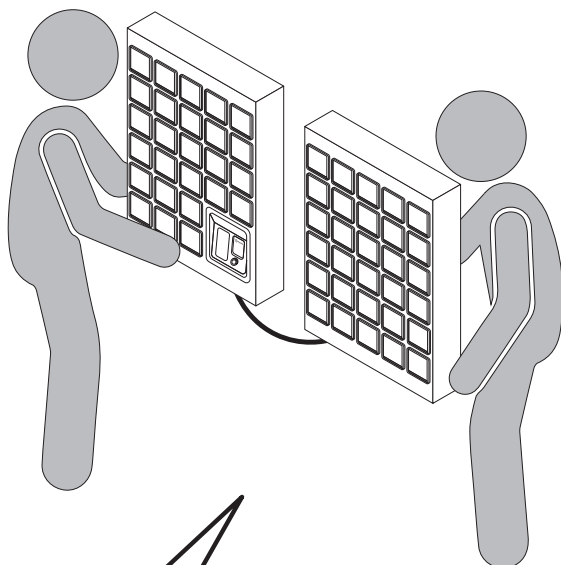

Warnings: If a SmartBox is dropped, do not proceed with the installation. Make sure you plug all the systems in and test to ensure all the SmartBoxes still connect.

If the CAT 5 Cable between SmartBox connections is damaged, power down the system and replace the cable. Do not operate the system with a damaged CAT 5 Ethernet Cable.

1.

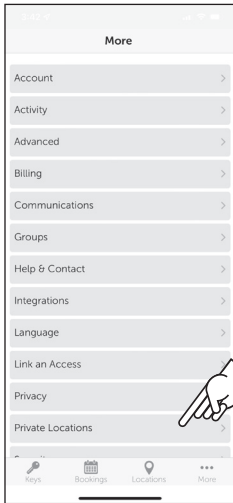

Select "More" and then "Private Locations" in the Keycafe App

a.

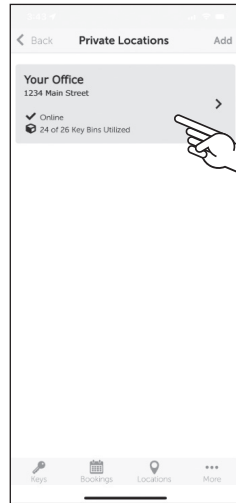

Select the location you are adding the Expansion to

b.

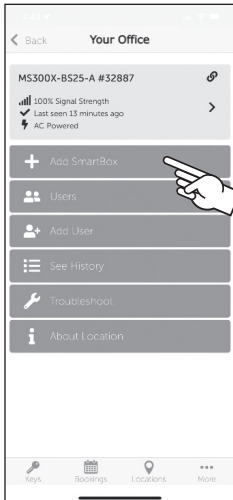

Select "Add SmartBox"

c.

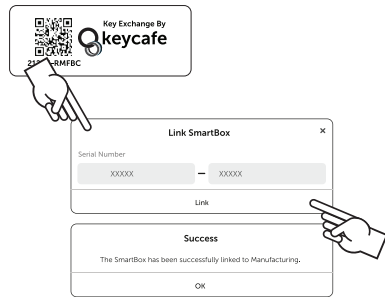

Enter the serial number found on the right side of the Expansion SmartBox and select "Link"

d.

2. EXPANSION SMARTBOX



IMPORTANT: Connect the CAT 5 Ethernet cable to the port closest to the front of the SmartBox.

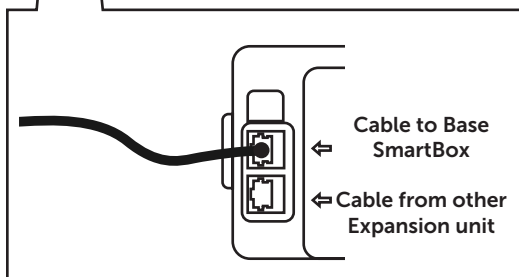
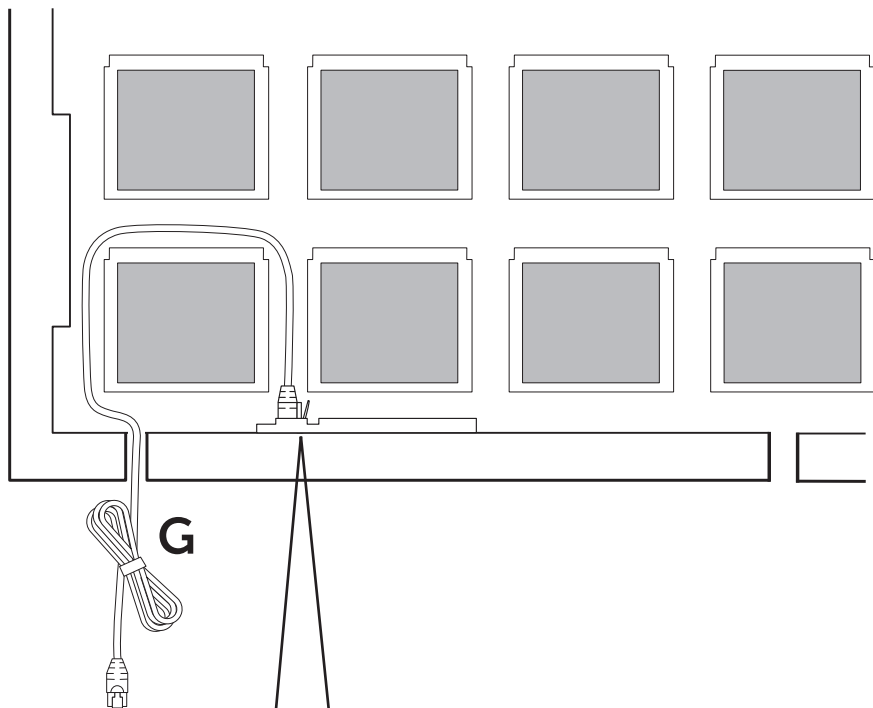

3. BASE SMARTBOX



IMPORTANT: Connect the CAT 5 Ethernet cable to the port closest to the backplate.

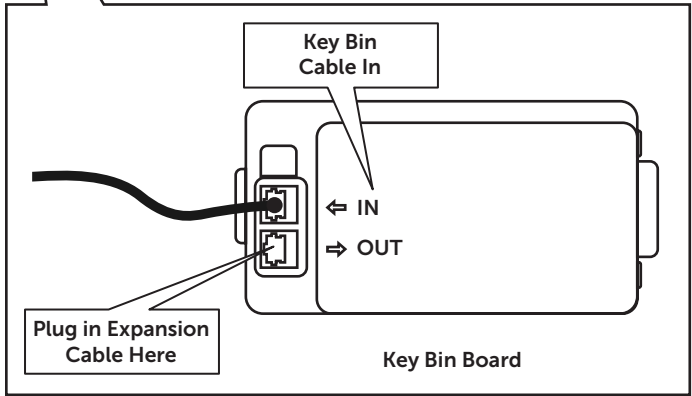
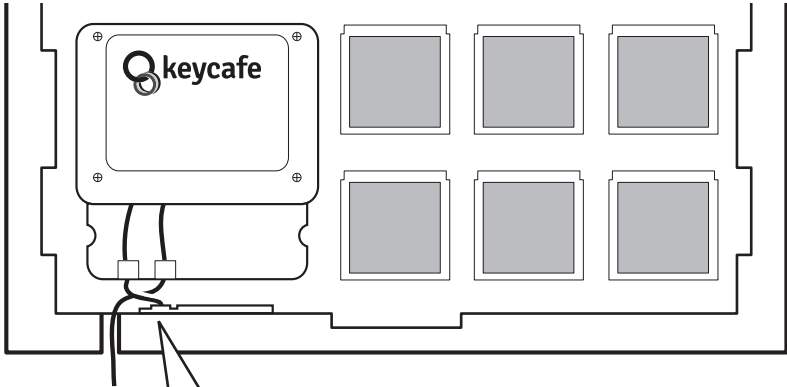

4.



IMPORTANT: Test the connection before mounting.

Once the cables between the Base Station and the Expansion are connected, test the system prior to mounting.

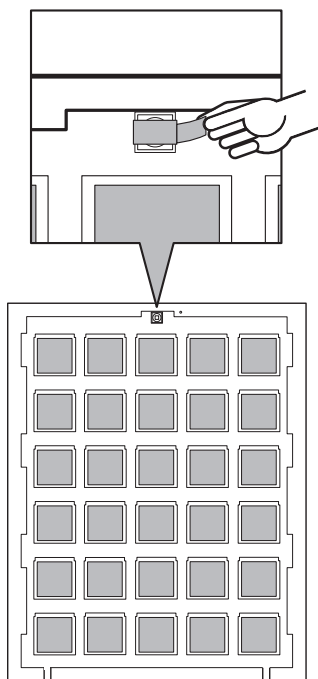

Remove tape from lock

a.

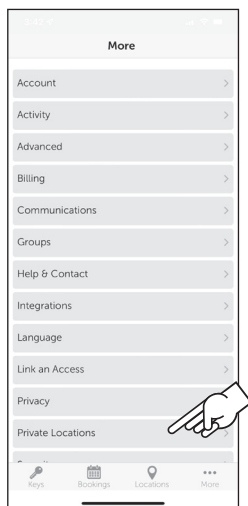

Select "More" and then "Private Locations" in the Keycafe App

b.

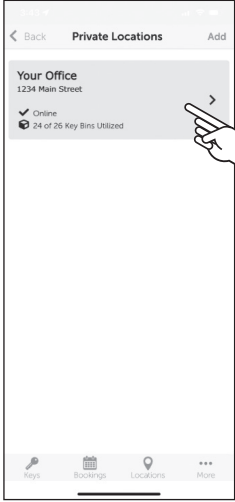

Private Locations

Your Office
1234 Main Street

✓ Online
24 of 26 Key Bins Utilized

Keys Bookings Locations More

c.

Select the location you just added the Expansion to

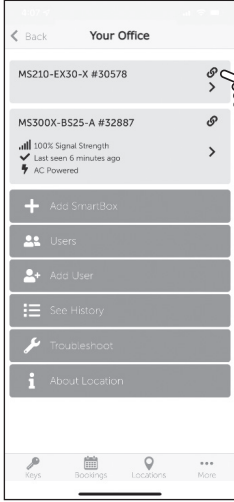

Your Office

MS210-EX30-X #30578

MS300X-B525-A #32887

100% Signal Strength
✓ Last seen 6 minutes ago
AC Powered

+ Add SmartBox

Users

+ Add User

See History

Troubleshoot

About Location

Keys Bookings Locations More

d.

Select the link icon of the Expansion you just added

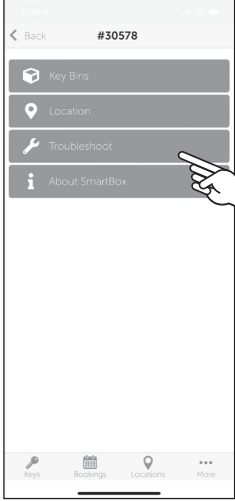

#30578

Key Bins

Location

Troubleshoot

About SmartBox

Keys Bookings Locations More

e.

Select "Troubleshoot"

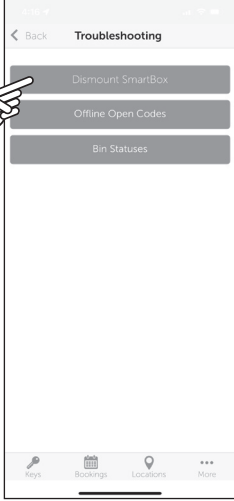

Troubleshooting

Dismount SmartBox

Offline Open Codes

Bin Statuses

Keys Bookings Locations More

f.

Select "Dismount SmartBox"

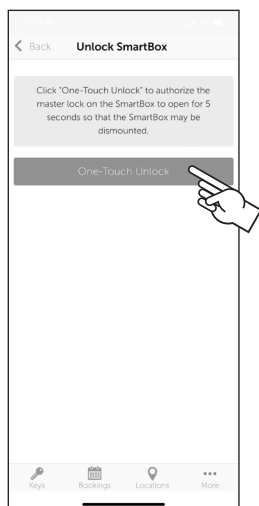

Select "One-Touch Unlock"

g.

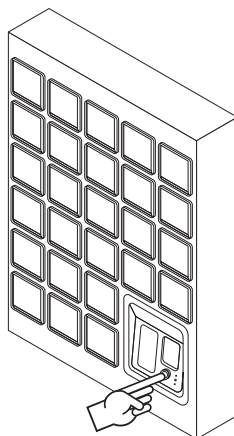

Press the button on the base SmartBox. If the lock opens, proceed to step 5.

h.

5.

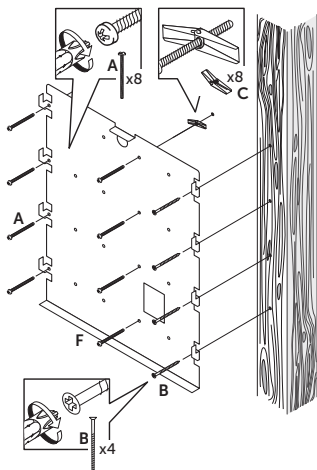

Important: Line up one row of holes along a stud in the wall and use the B screw.

Placement Considerations

When installing your MS3E Expansion SmartBox, there are four major placement considerations that will ensure you get the optimal performance and longevity out of your system.



Safety

The SmartBox must be installed with screws onto wooden studs minimum size 2" x 4" (5cm x 10 cm) or concrete block minimum thickness 8" (20cm). Ensure the power outlet, environment and installation approach meets all requirements and standards in accordance with documentation available at www.keycafe.com as well as local laws, regulations and guidelines related to fixed installations. Always install with 2 people to prevent dropping the SmartBox with cables attached.



Security

Install in a well-lit, surveilled area to reduce the risk of theft or vandalism. The Keycafe SmartBox is a convenient way to manage key access and can be damaged or broken into if left unattended in unsecured areas.



Accessibility

The installation area should consider all users of the SmartBox so they can reach all bins, the scanner and keypad, as well as continued accessibility of pathways and halls the SmartBox is installed into. We recommend at a minimum adhering to US ADA guidelines which recommend the max height of the top of the SmartBox to be 48" (122cm) from the floor and a minimum of 48" (75cm) of obstruction-free space in front, but you should also check any local regulations or guidelines that may be applicable to your installation. Learn more about the ADA guidelines at (www.olea.com/news/ada-compliant-interactive-kiosks/).



Expandability

If you plan to purchase more MS3E expansion units in the future, keep in mind the space required for them. Each expansion requires a min of 19" x 24" (48cm x 60cm) area to install. You can mount expansions on either side of the base station.

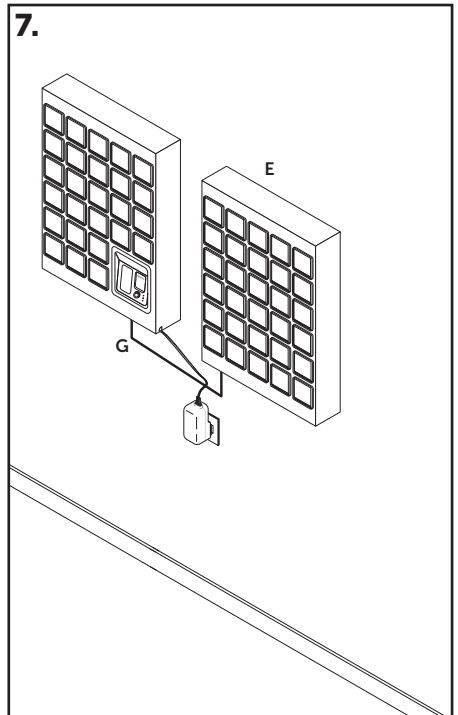
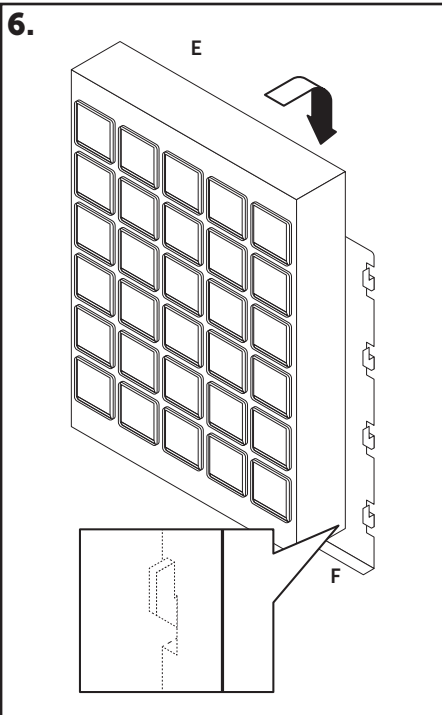



LOURD. 12KG (25LBS)

IMPORTANT : 2 personnes sont nécessaires pour l'installation. Assurez-vous que chaque SmartBox soit maintenue de manière à éviter toute tension sur le câble ethernet et ainsi ne pas endommager le système.

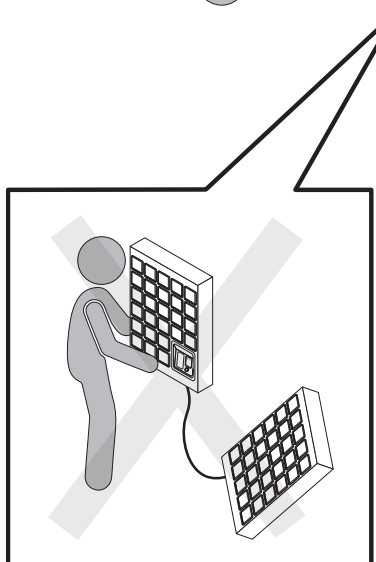
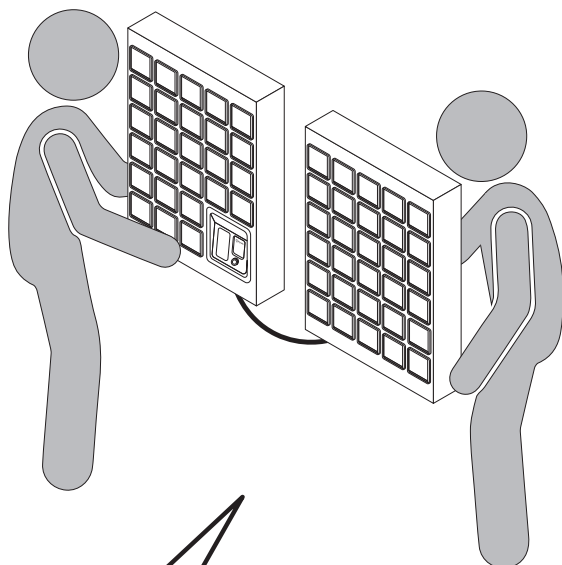

Avertissement : Si une SmartBox est tombée, ne procédez pas à l'installation. Assurez-vous de brancher tous les systèmes et faites un test pour vous assurer que toutes les SmartBox sont toujours connectées.

Si le câble CAT 5 entre les connexions de la SmartBox est endommagé, mettez le système hors tension et remplacez le câble. Ne faites pas fonctionner le système avec un câble Ethernet CAT 5 endommagé.

1.

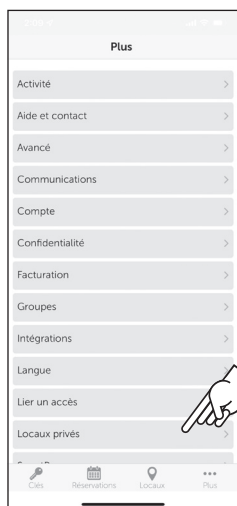

Sélectionnez "Plus" et ensuite
"Emplacements privés" dans
l'application Keycafe

a.

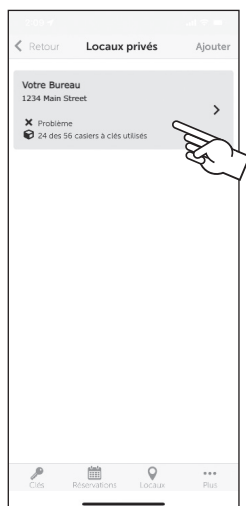

Sélectionnez l'emplacement auquel
vous ajoutez l'extension

b.



Appuyez sur « Ajouter une
SmartBox »

c.



Numéro de série



Entrez le numéro de série qui
se trouve sur le coté droit de
l'extension Smartbox et Appuyez sur
« Connecter »

d.

2. EXTENSION DE LA SMARTBOX



IMPORTANT: Connectez le câble Ethernet CAT 5 au port le plus à l'avant de la SmartBox.

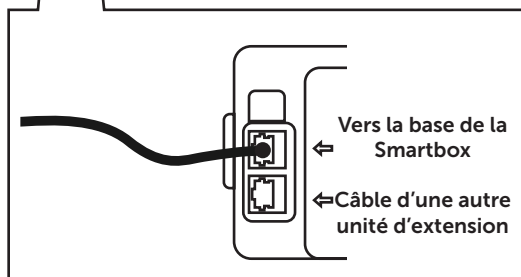
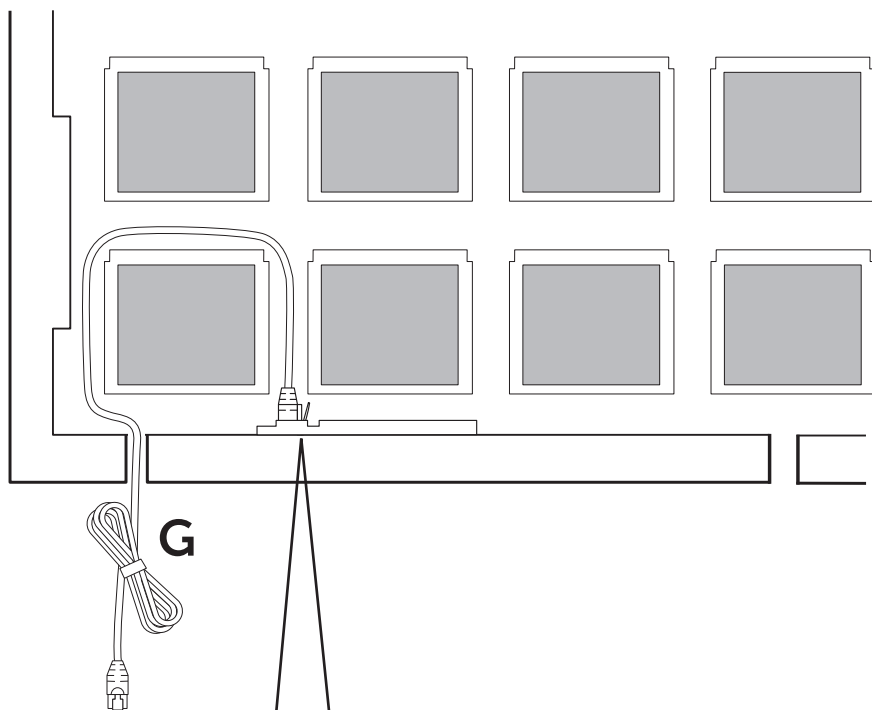

3. BASE DE LA SMARTBOX



IMPORTANT: Connectez le câble Ethernet CAT 5 au port le plus proche de la plaque arrière.

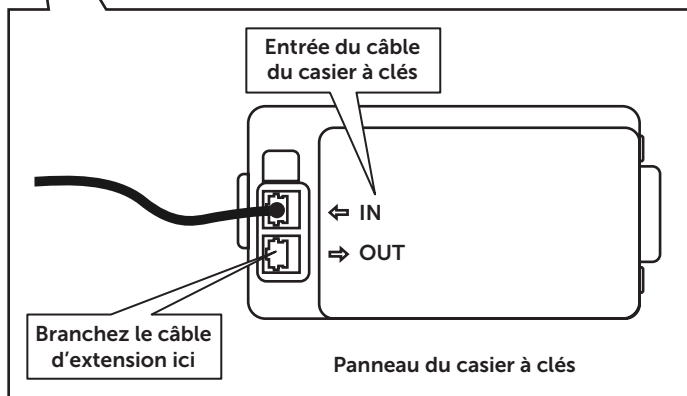
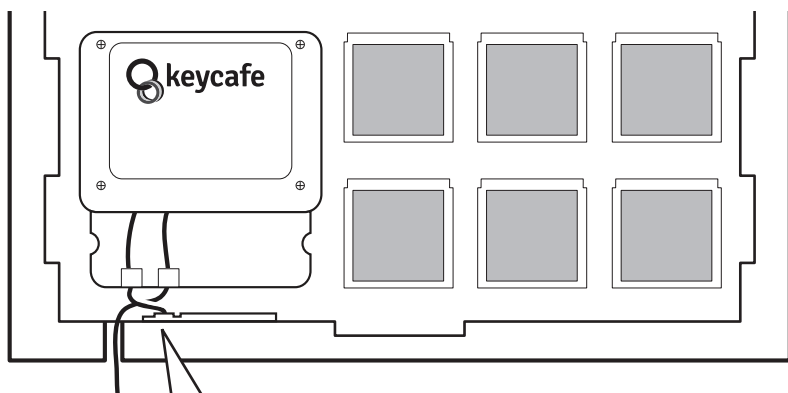

4.



IMPORTANT: Testez la connexion avant le montage.

Une fois que les câbles entre la station de base et l'extension sont connectés, testez le système avant de monter la Smartbox.

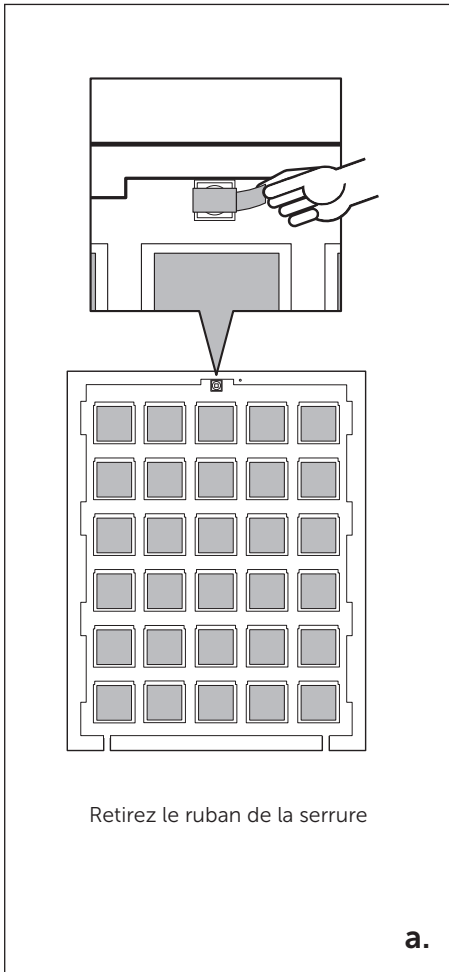



Sélectionnez l'emplacement auquel vous venez d'ajouter l'extension

c.



Sélectionnez l'icône de lien de l'extension que vous venez d'ajouter

d.

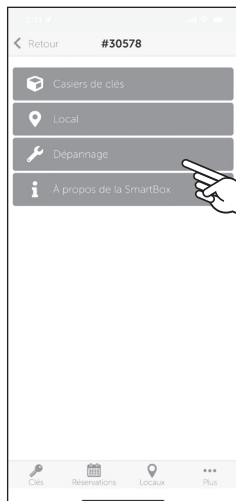

Appuyez sur « Dépannage »

e.



Appuyez sur « Démontez la Smartbox »

f.

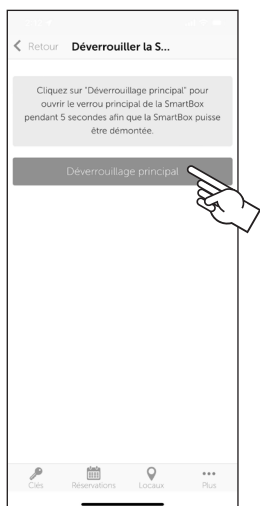

Appuyez sur « Déverrouillage principal »

g.

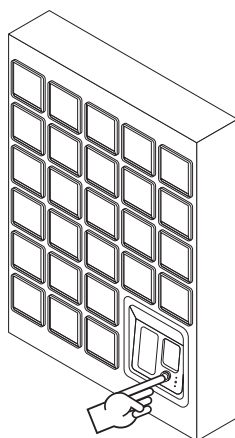

Appuyez sur le bouton de la station de base lorsqu'il clignote en rouge. Si le verrou de l'extension Smartbox s'ouvre, passez à l'étape 5

h.

5.

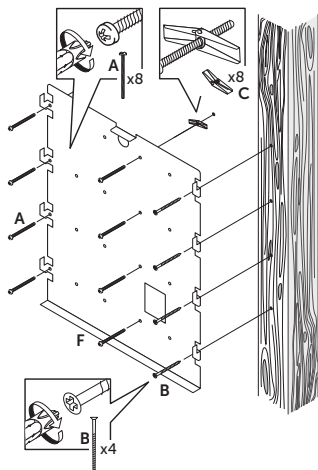

IMPORTANT : Alignez une rangée de trous le long d'un montant dans le mur et utilisez la vis B.

Considérations relatives à l'emplacement

Lors de l'installation de votre SmartBox d'extension MS3E, il y a quatre considérations de placement majeures qui vous assureront d'obtenir les performances et la longévité optimales de votre système.



Sécurité

La SmartBox doit être installée avec des vis sur des montants en bois de taille minimum 2" x 4" (5 cm x 10 cm) ou un bloc de béton d'une épaisseur minimum de 8" (20 cm). Assurez-vous que la prise de courant, l'environnement et l'approche d'installation répondent à toutes les exigences et normes conformément à la documentation disponible sur www.keycafe.com ainsi qu'aux lois, réglementations et directives locales relatives aux installations fixes. Assurez-vous d'installer à 2 personnes pour éviter que la SmartBox tombe avec les câbles attachés.



Sûreté

Installez dans un endroit bien éclairé et surveillé pour réduire les risques de vol ou de vandalisme. La SmartBox Keycafe est un moyen pratique de gérer l'accès aux clés et peut être endommagée ou cassée si elle est laissée sans surveillance dans des zones non sécurisées.



Accessibilité

La zone d'installation doit tenir compte de tous les utilisateurs de la SmartBox afin qu'ils puissent atteindre tous les casiers, le scanner et le clavier, ainsi que l'accessibilité continue des chemins et des halls dans lesquels la SmartBox est installée. Nous vous recommandons d'adhérer au minimum aux directives de l'US ADA qui recommandent que la hauteur maximale du haut de la SmartBox soit de 48" (122 cm) du sol et un minimum de 48" (75 cm) d'espace libre devant, mais vous devriez également vérifier toutes les réglementations ou directives locales qui peuvent être applicables à votre installation. En savoir plus sur les directives de l'ADA sur (www.olea.com/news/ada-compliant-interactive-kiosks/).



Extensibilité

Si vous prévoyez d'acheter plus d'unités d'extension MS3E à l'avenir, gardez à l'esprit l'espace requis pour celles-ci. Chaque extension nécessite une superficie minimale de 19" x 24" (48 cm x 60 cm) pour l'installer. Vous pouvez monter des extensions de chaque côté de la station de base.

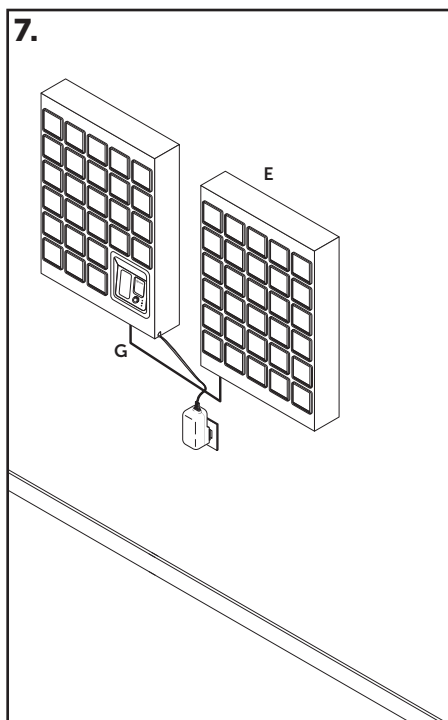
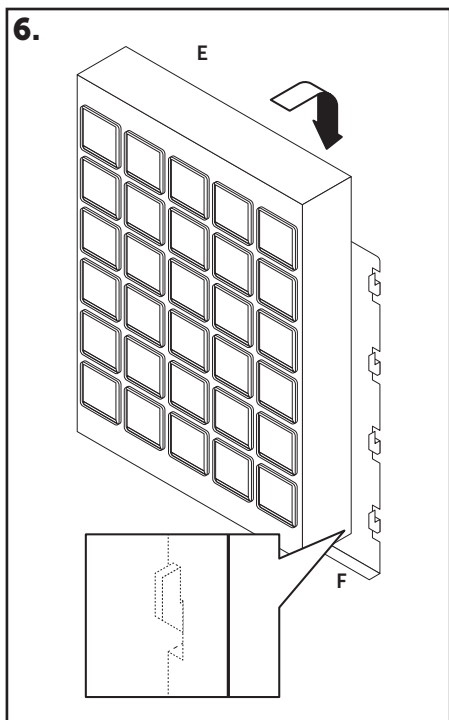



重量: 12KG

重要: 設置は2人で行ってください。システムに支障をきたさない為に、各端末はイーサネットケーブルを圧迫しないように設置してください。

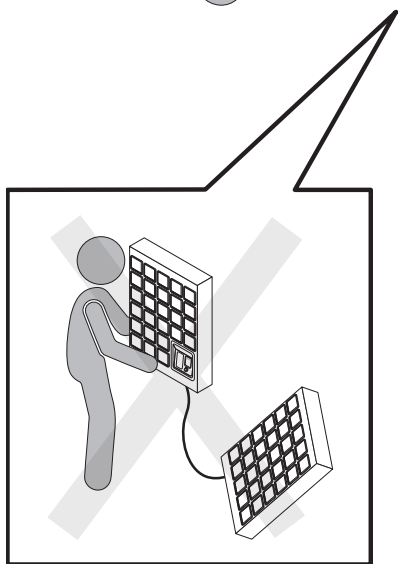
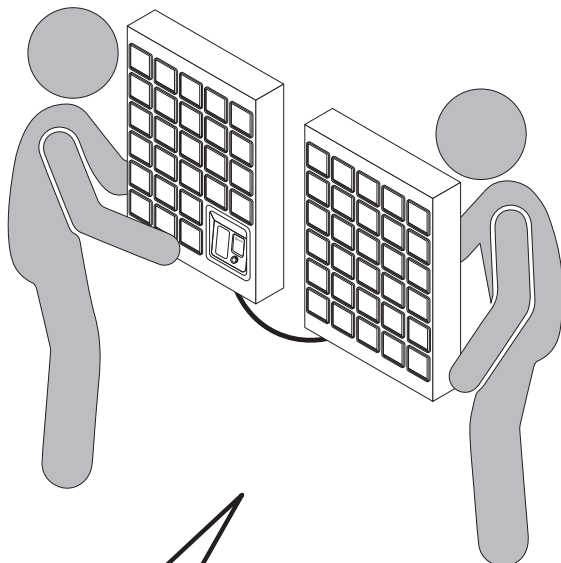

注意: 端末を落とした場合には、いったん設置を止めてください。端末に電源が入っている状態で、オンラインになることを確認してください。

端末を連結するCAT5ケーブルが破損した場合は、電源を抜いてケーブルを差し替えてください。破損されたCAT5ケーブルを接続したまま端末を利用しないでください。

1.



Keycafeアプリから「もっと見る」をタップして「専用ロケーション」を選択します。

a.

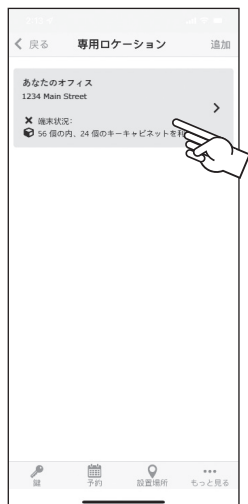

拡張用端末を追加するロケーションを選んでください。

b.



「SmartBoxを追加」に進みます。

c.



シリアル番号



拡張用端末の右側面に印字されているシリアル番号をアプリ画面に入力して、「リンク」をタップします。

d.

2. 拡張用端末



重要: キャビネット前面に一番近い差込口にCAT5イーサネットケーブルを差し込んでください。

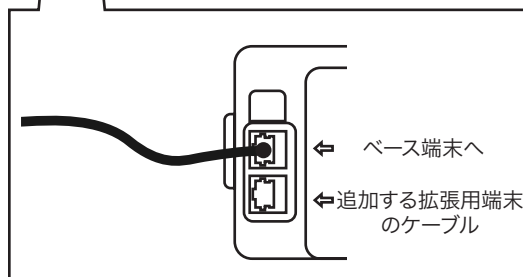
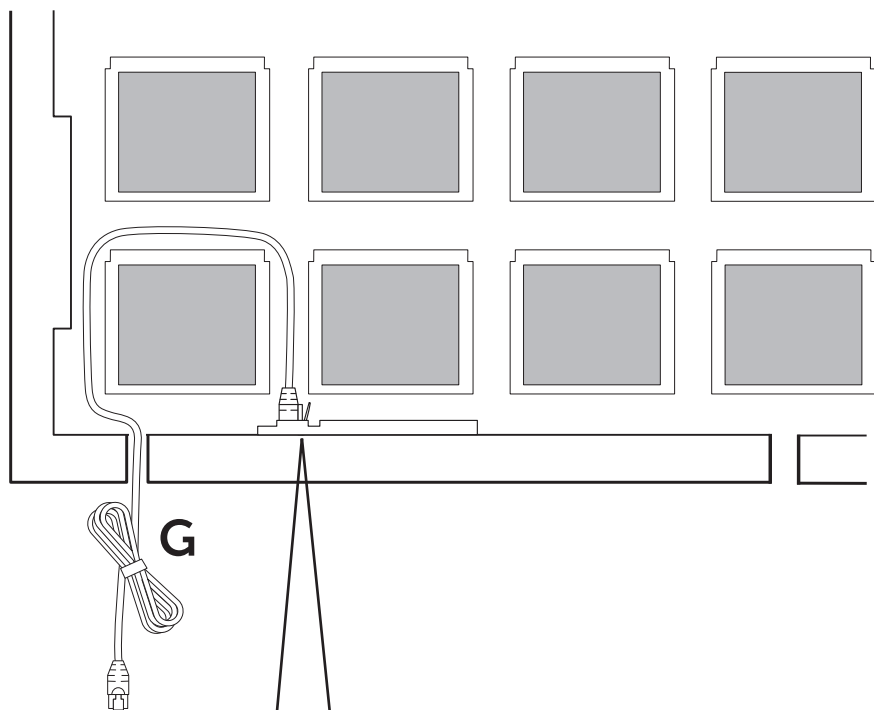

3. ベース端末



重要: 背面パネルに一番近い差込口にCAT5イーサネットケーブルを差し込んで下さい。

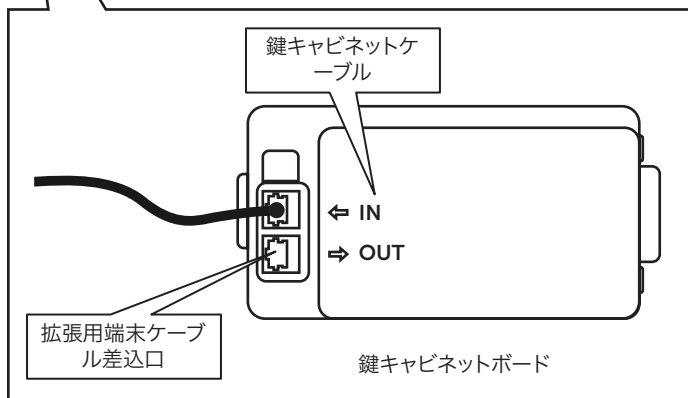
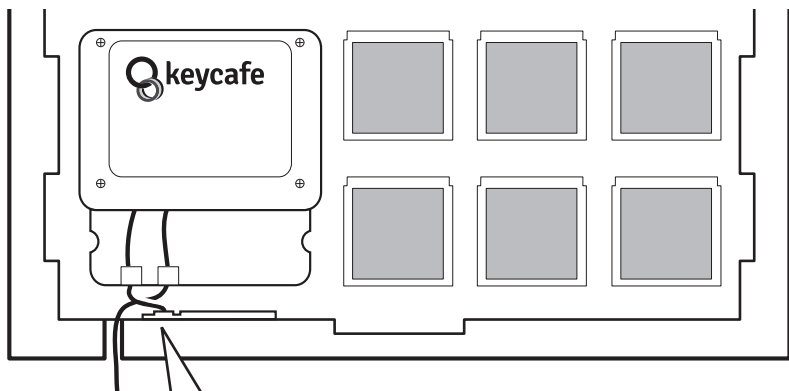

4.



重要: 設置前に、端末がオンラインになっていることを確認してください。

ベース端末と拡張用端末をケーブルで繋げた状態で、設置前に作動テストを行います。

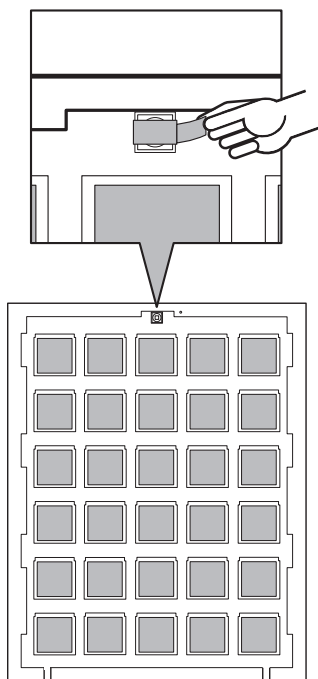

ロックからテープを外します。

a.

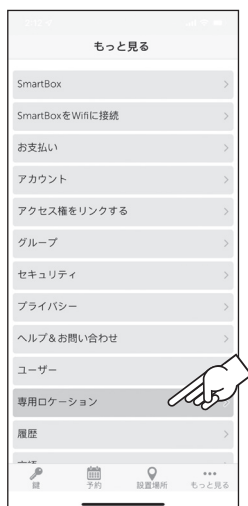

Keycafeアプリから「もっと見る」をタップして「専用ロケーション」を選択します。

b.



拡張用端末を追加したロケーションを選んでください。

c.



追加した拡張用端末のリンクアイコンをタップします。

d.



「トラブルシューティング」に進みます。

e.



「SmartBox を取り外す」を選択します。

f.

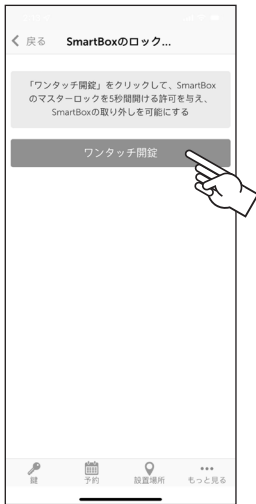

「SmartBoxのロックを解除」のダイヤログボックスで、「ワンタッチ開錠」をクリックします。

g.

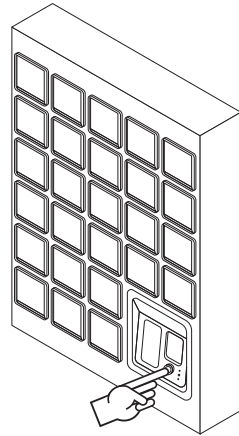

ベース端末のボタンが赤く光ったら、正面からしっかりボタンを押します。拡張用端末のロックが解除されたら、ステップ5に進んでください。

h.

5.

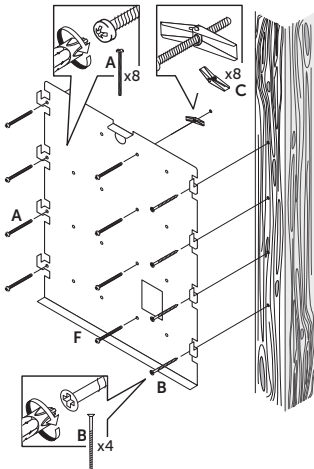

重要:下地のある壁にビスを打ち込んでください

設置の注意点

拡張用端末 (MS3E) を設置する際には、以下4つの注意点を考慮してください



安全

SmartBoxは5cm x 10cm 以上の木製下地、または20cm以上の厚さのコンクリートにビス留めで設置してください。電源、その他設置環境・設置方法が、www.keycafe.comに記載の必要条件と、設置場所における法律、条例に順することをご確認ください。設置の際にSmartBoxを落とさないよう、2名での作業をお勧めします。



セキュリティ

盗難・破壊を避ける為、明るく、監視可能な場所に設置してください。Keycafeは利便性の高い鍵管理サービスですが、治安の悪い場所に放置されると壊される可能性もございます。



アクセシビリティ

SmartBoxの全ての鍵キャビネット、スキャナとタッチパネルが利用できる環境に設置してください。鍵の受け渡しが必要な時間帯に、利用者がアクセスできることも必要です。Keycafeはアメリカ障害者法 (ADA) ガイドラインの遵守を奨励しています。SmartBoxの上部が地面から122cmまで、SmartBoxの前に最低限75cmの障害物の無いスペースを確保することが推奨されます。



拡張用端末

拡張用端末 (MS3E) の追加購入を検討されている場合は、追加端末の設置スペースも念頭に置いてください。拡張用端末の設置には48cm x 60cm のスペースが必要で、ベース端末の横、又は下側に設置されます。

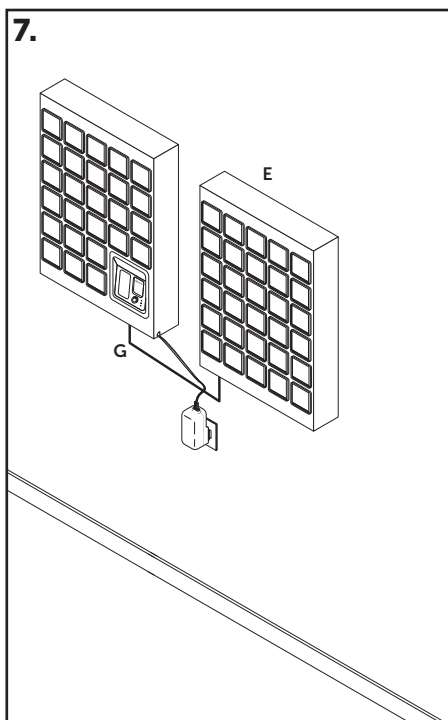
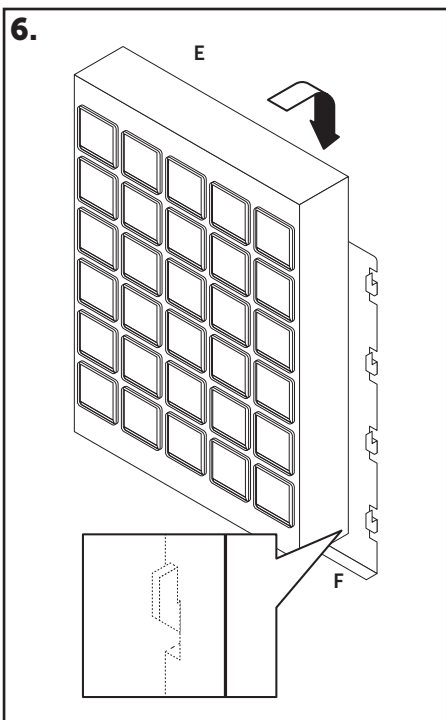



support.keycafe.com