



support.keycafe.com

Scan to watch
installation video

Scannez pour regarder
la vidéo d'installation

スキャンして、設置案内動画
を確認しましょう



keycafe.com/ml/ms5e

MS5E-18

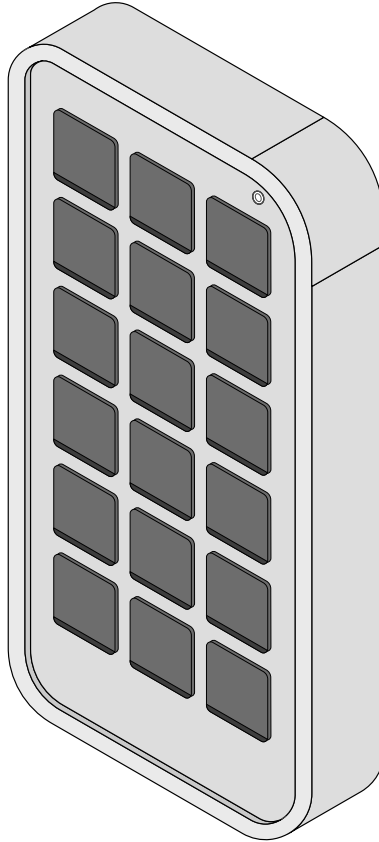

ENGLISH

STOP - Do not install until you have read the instructions.

FRANÇAIS

ATTENTION - N'installez pas tant que vous n'avez pas lu les instructions.

日本語

注意 - こちらの説明書に目を通してから設置してください

English.....	3
Français.....	10
日本語.....	17

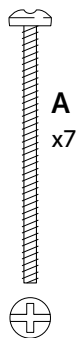

A
x7



B
x5

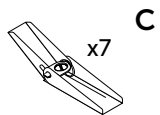

C
x7

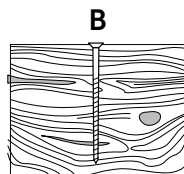

B

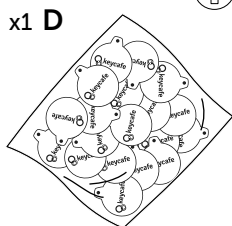

x1 D

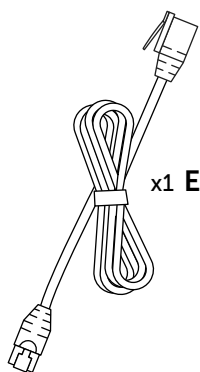

x1 E

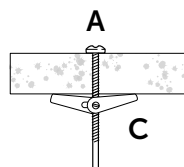

A

C

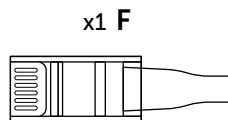

x1 F

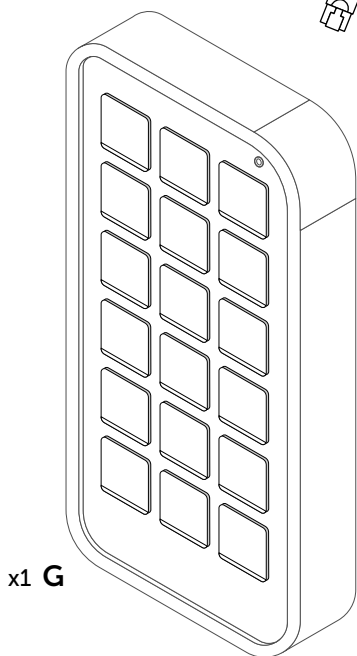

x1 G

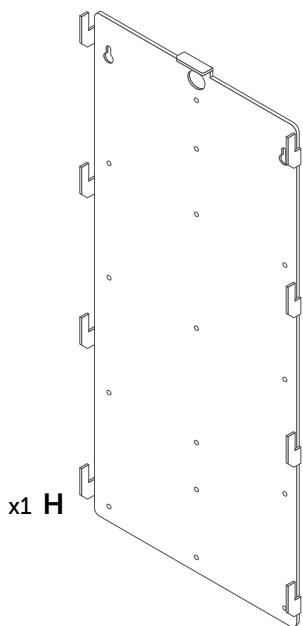

x1 H

Placement Considerations

When installing your MS5E-18 Expansion SmartBox, there are four major placement considerations that will ensure you get the optimal performance and longevity out of your system.



Safety

The SmartBox must be installed with screws onto wooden studs minimum size 2" x 4" (5cm x 10 cm) or concrete block minimum thickness 8" (20cm). Ensure the power outlet, environment and installation approach meets all requirements and standards in accordance with documentation available at www.keycafe.com as well as local laws, regulations and guidelines related to fixed installations. Always install with 2 people to prevent dropping the SmartBox with cables attached.



Security

Install in a well-lit, surveilled area to reduce the risk of theft or vandalism. The Keycafe SmartBox is a convenient way to manage key access and can be damaged or broken into if left unattended in unsecured areas.



Accessibility

The installation area should consider all users of the SmartBox so they can reach all bins, the scanner and keypad, as well as continued accessibility of pathways and halls the SmartBox is installed into. We recommend at a minimum adhering to US ADA guidelines which recommend the max height of the top of the SmartBox to be 48" (122cm) from the floor and a minimum of 48" (75cm) of obstruction-free space in front, but you should also check any local regulations or guidelines that may be applicable to your installation. Learn more about the ADA guidelines at www.keycafe.com/ml/accessibility



Expandability

If you plan to purchase more expansion units in the future, keep in mind the space required for them. Each MS5E-18 requires a min of 11.4" x 23.3" (29cm x 59cm) area to install. Each MS5E-42 requires a min of 23.8" x 23.3" (60.5cm x 59cm). You can mount expansions on either side of the base station.

1. MOUNT BACKPLATE

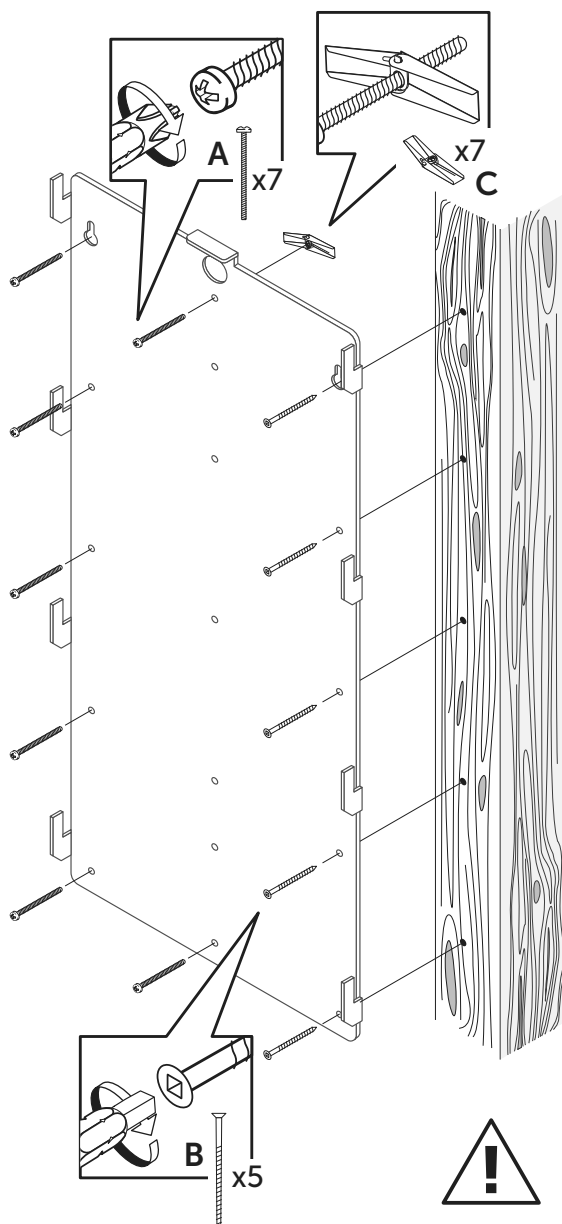

Important: Line up one row of holes along a stud in the wall and use the B screw.

2. MOUNT SMARTBOX

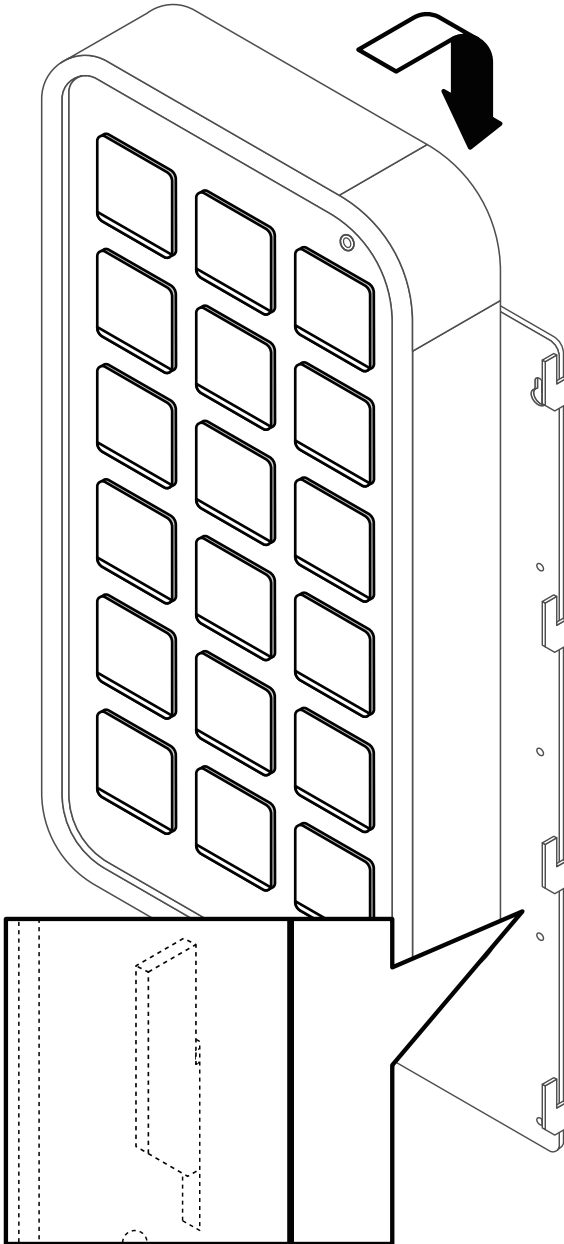

3. MOUNTING COMPLETE

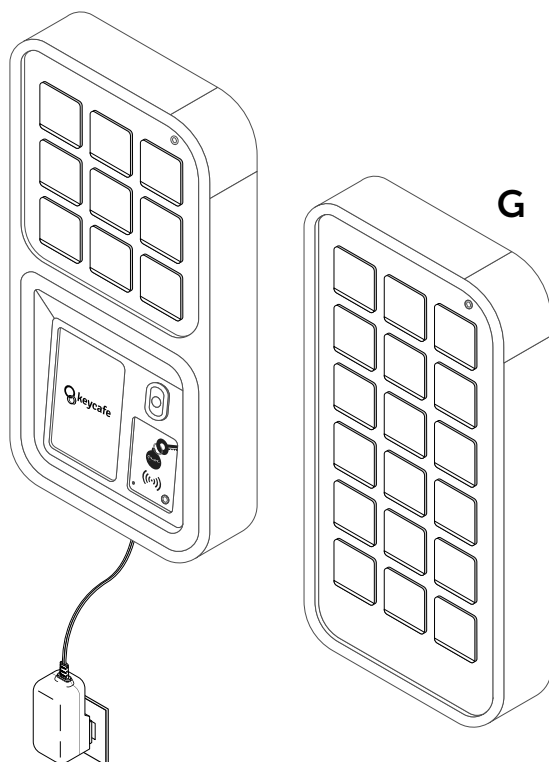

4. PLUG IN CABLE



IMPORTANT: Connect one end of the CAT 6 PoE Ethernet cable into the **green Expansion Out port of the MS5E-18 Expansion SmartBox**, and the other end into the **orange Expansion In port of the MS5 Base SmartBox**.

If you have 4+ Expansion SmartBoxes, plug the Termination Dongle (F) into the **orange Expansion In port** of the final Expansion SmartBox in the chain.



**Expansion In
(Orange)**



**Expansion Out
(Green)**

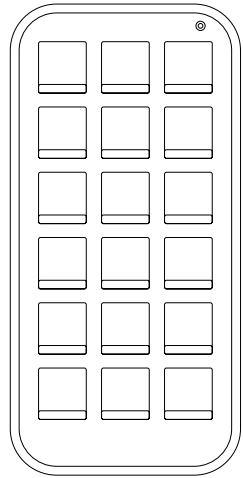
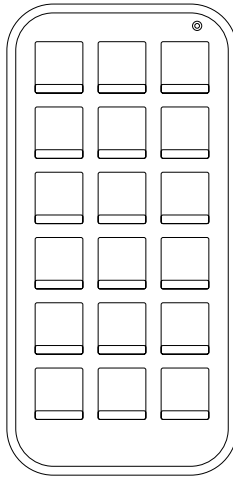
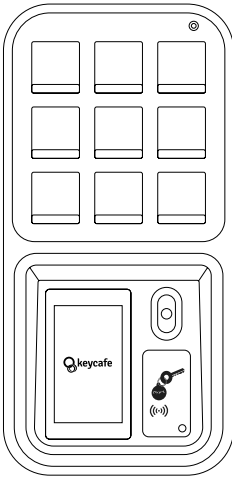

(Orange)



(Green)



(Orange)



(Green)



(Orange)



E



More Expansions
or Termination
Dongle

5. ADD SMARTBOX TO ACCOUNT



Scan to watch video

keycafe.com/ml/add_smartbox

6. TEST THE SMARTBOX



Scan to watch video

keycafe.com/ml/test_smartbox

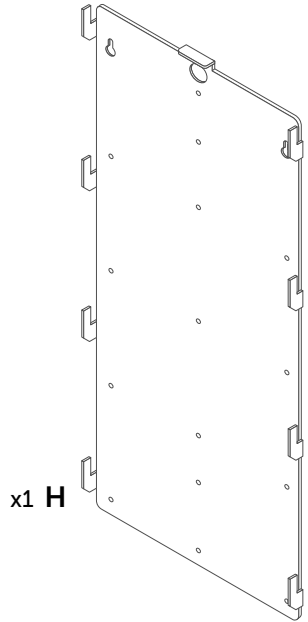
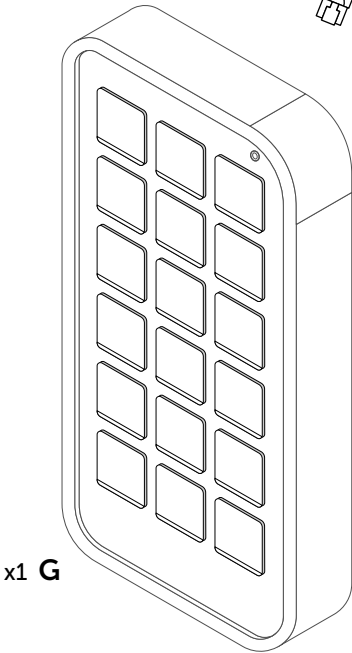
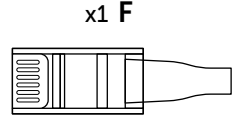
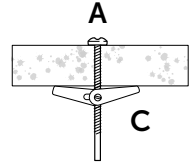
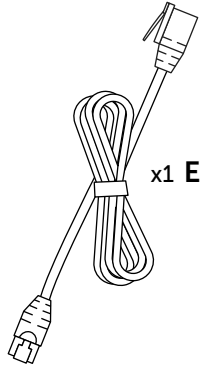
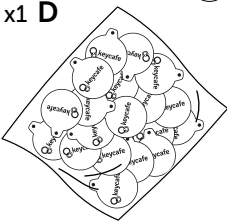
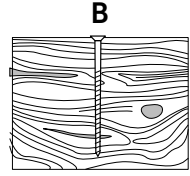
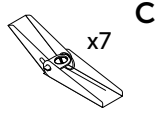
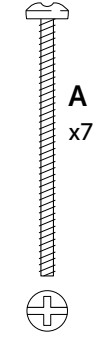

Considérations relatives à l'emplacement

Lors de l'installation de votre SmartBox d'extension MS5E-18, il y a quatre considérations de placement majeures qui vous assureront d'obtenir les performances et la longévité optimales de votre système.



Sécurité

La SmartBox doit être installée avec des vis sur des montants en bois de taille minimum 2" x 4" (5 cm x 10 cm) ou un bloc de béton d'une épaisseur minimum de 8" (20 cm). Assurez-vous que la prise de courant, l'environnement et l'approche d'installation répondent à toutes les exigences et normes conformément à la documentation disponible sur www.keycafe.com ainsi qu'aux lois, réglementations et directives locales relatives aux installations fixes. Assurez-vous d'installer à 2 personnes pour éviter que la SmartBox tombe avec les câbles attachés.



Sûreté

Installez dans un endroit bien éclairé et surveillé pour réduire les risques de vol ou de vandalisme. La SmartBox Keycafe est un moyen pratique de gérer l'accès aux clés et peut être endommagée ou cassée si elle est laissée sans surveillance dans des zones non sécurisées.



Accessibilité

La zone d'installation doit tenir compte de tous les utilisateurs de la SmartBox afin qu'ils puissent atteindre tous les casiers, le scanner et le clavier, ainsi que l'accessibilité continue des chemins et des halls dans lesquels la SmartBox est installée. Nous vous recommandons d'adhérer au minimum aux directives de l'US ADA qui recommandent que la hauteur maximale du haut de la SmartBox soit de 48" (122 cm) du sol et un minimum de 48" (75 cm) d'espace libre devant, mais vous devriez également vérifier toutes les réglementations ou directives locales qui peuvent être applicables à votre installation. En savoir plus sur les directives de l'ADA sur (www.keycafe.com/ml/accessibility).



Extensibilité

Si vous avez acheté des unités d'extension ou prévoyez de le faire à l'avenir, gardez à l'esprit l'espace requis pour celles-ci. Chaque MS5E-18 nécessite une superficie minimale de 29cm x 59cm pour l'installer. Chaque MS5E-42 nécessite une superficie minimale de 60.5cm x 59cm pour l'installer. Vous pouvez monter des extensions de chaque côté de la station de base.

1. MONTER LA PLAQUE ARRIÈRE

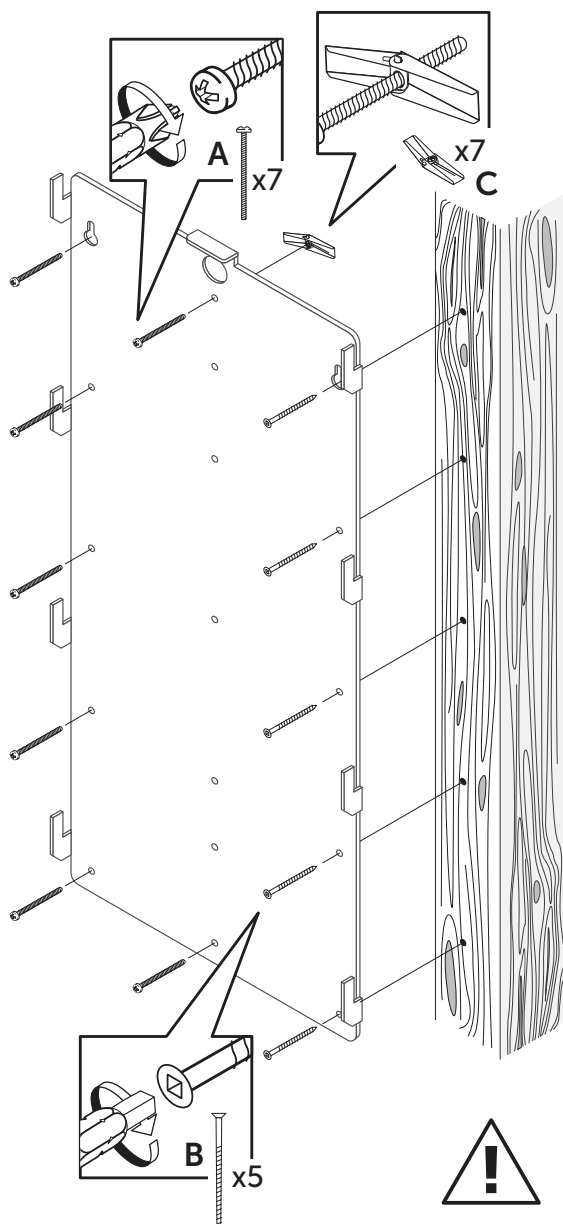

IMPORTANT: Aligned une rangée de trous le long d'un montant dans le mur et utilisez la vis B.

2. MONTER LA SMARTBOX

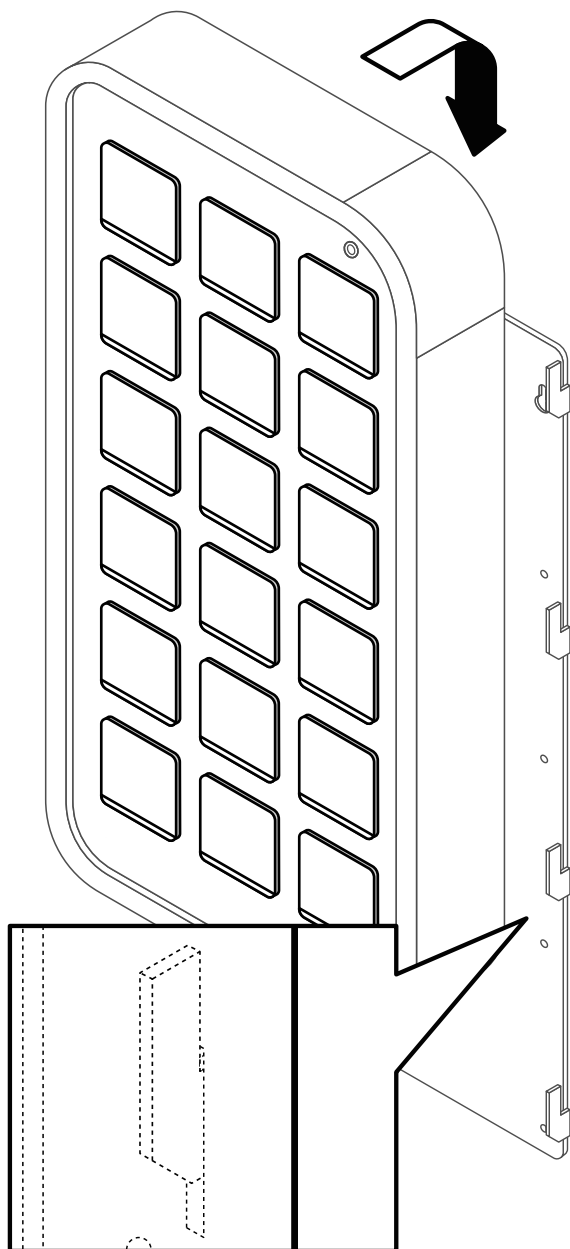

3. MONTAGE COMPLET

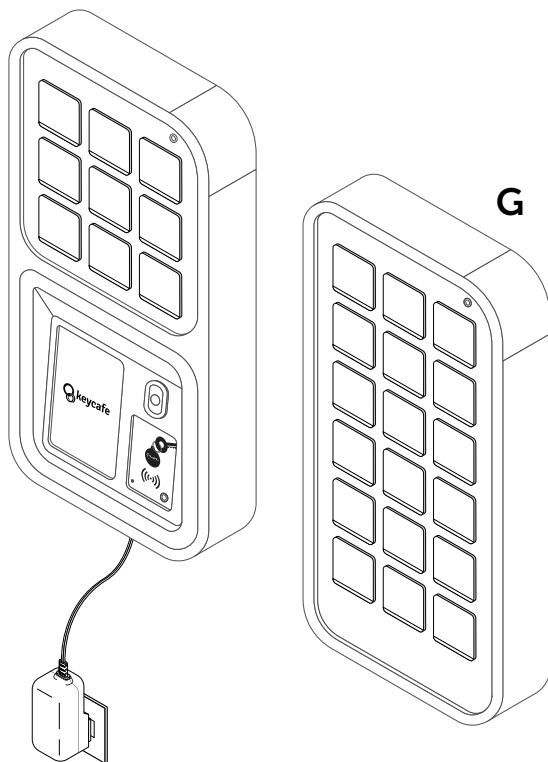

4. BRANCHER LE CÂBLE D'ALIMENTATION



IMPORTANT : Connectez une extrémité du câble Ethernet PoE CAT 6 au **port vert Sortie Extension de la SmartBox d'extension MS5E-18** et l'autre extrémité au **port orange Entrée Extension de la SmartBox de base MS5**.

Si vous avez plus de 4 SmartBox d'extension, branchez le dongle de terminaison (F) dans le **port orange d'entrée d'extension** de la dernière SmartBox d'extension de la chaîne.



**Entrée Extension
(Orange)**



**Sortie Extension
(Vert)**

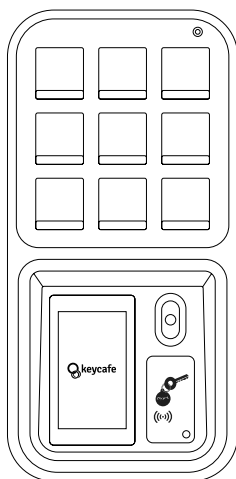

(Orange)

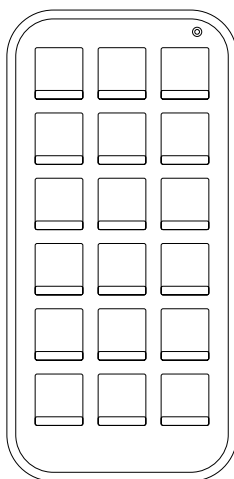

(Vert)



(Orange)

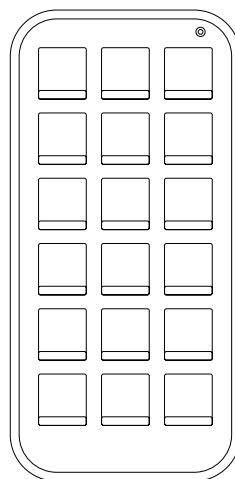

(Vert)



(Orange)

E

↓
Plus d'extensions
ou dongle de
terminaison

5. AJOUTER LA SMARTBOX AU COMPTE



Scannez pour regarder la vidéo

keycafe.com/ml/add_smartbox

6. TESTER LA SMARTBOX



Scannez pour regarder la vidéo

keycafe.com/ml/test_smartbox

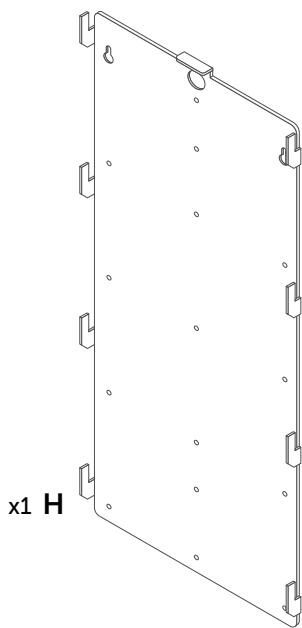
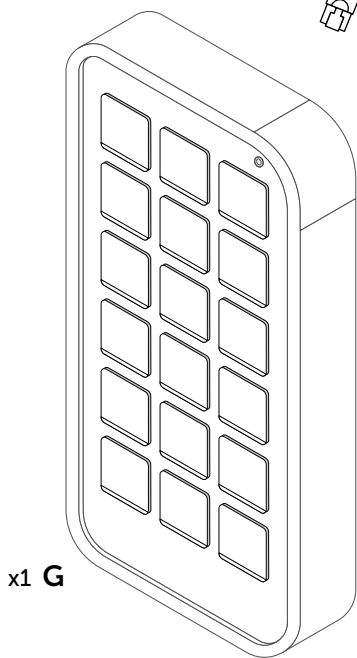
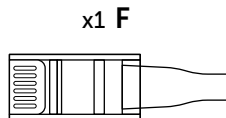
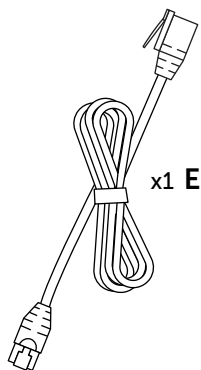
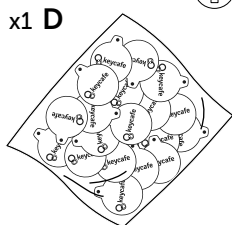
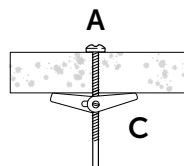
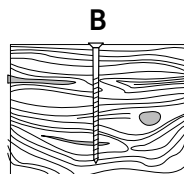
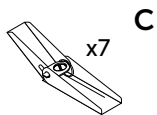
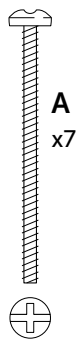

設置の注意点

拡張用端末 (MS5E-18) を設置する際には、以下4つの注意点を考慮してください



安全

SmartBoxは5cm x 10cm 以上の木製下地、または20cm以上の厚さのコンクリートにビス留めで設置してください。電源、その他設置環境・設置方法が、www.keycafe.comに記載の必要条件と、設置場所における法律、条例に順することをご確認ください。設置の際にSmartBoxを落とさないよう、2名での作業をお勧めします。



セキュリティ

盗難・破壊を避ける為、明るく、監視可能な場所に設置してください。Keycafeは利便性の高い鍵管理サービスですが、治安の悪い場所に放置されると壊される可能性もございます。



アクセシビリティ

SmartBoxの全ての鍵キャビネット、スキャナとタッチパネルが利用できる環境に設置してください。鍵の受け渡しが必要な時間帯に、利用者がアクセスできることも必要です。Keycafeはアメリカ障害者法 (ADA) ガイドラインの遵守を奨励しています。SmartBoxの上部が地面から122cmまで、SmartBoxの前に最低限75cmの障害物の無いスペースを確保することが推奨されます。



拡張用端末

Smartboxの拡張用端末をご購入のお客様へ：①設置スペースはMS5E-18が29cm x 59cmのスペースが必要です。MS5E-42の場合 60.5cm x 59cm。②拡張端末は本体の左側、右側どちらでも設置可能です。

1. 背面パネルを壁に固定する

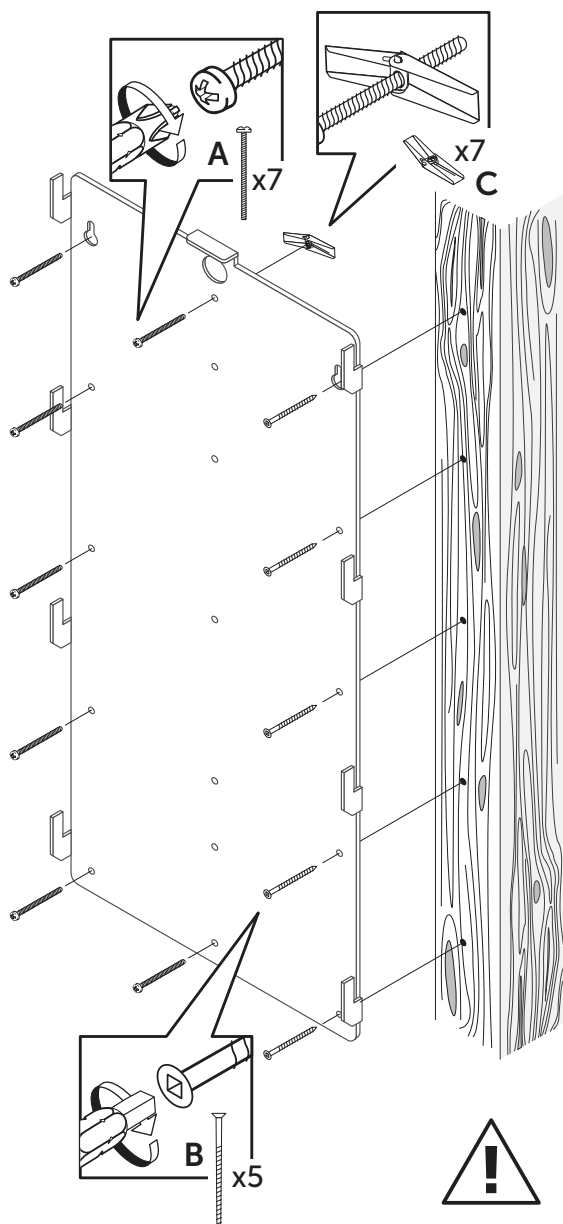

重要:下地のある壁にビスを打ち込んでください

2. SMARTBOX前面部分を背面パネルに嵌め込む

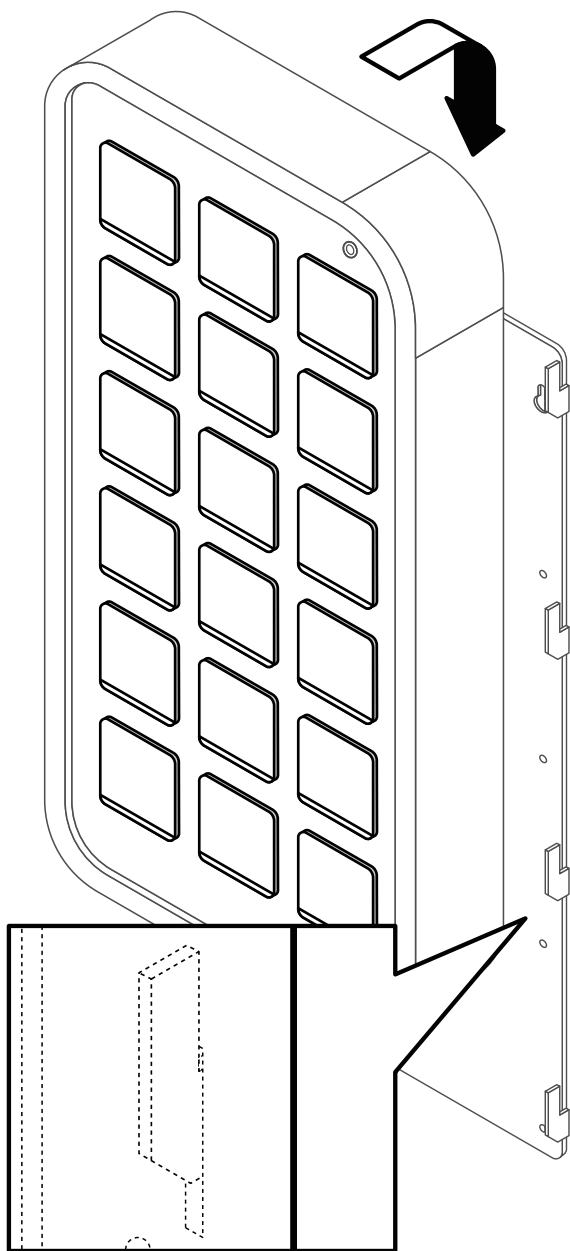

3. 設置完了

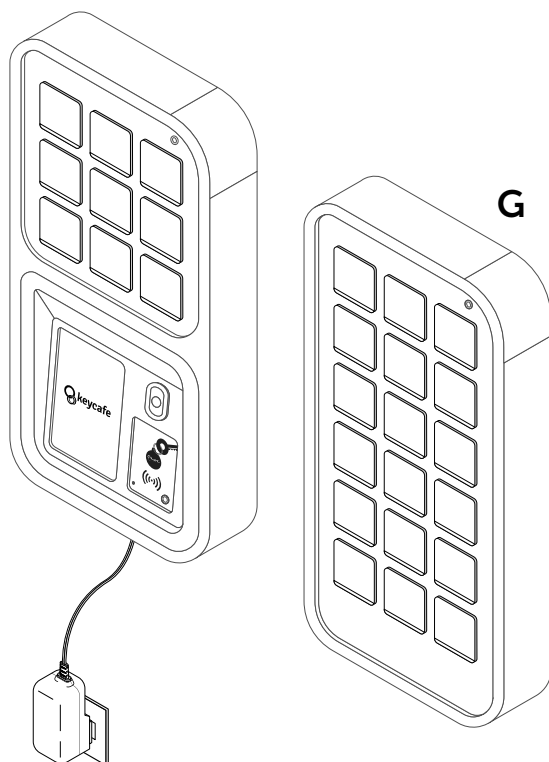

4. 電源コードを差し込む



注: 拡張用端末の緑色の差し込み口から、SmartBox本体のオレンジ色の差し込み口へ、ケーブルを繋ぎます。

4台以上の拡張用端末をご利用の場合、最後の拡張用端末のオレンジ色の差し込み口にターミナル装置を差し込んでください。



SmartBox拡張用
末へ(オレンジ)



SmartBox本体、または
本体に連結済みの拡張
用端末へ(緑)

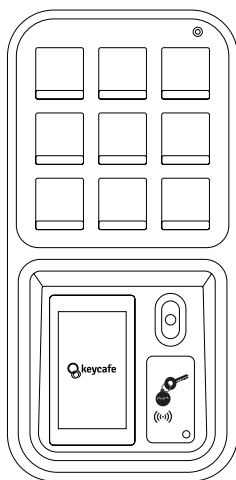

(オレンジ)

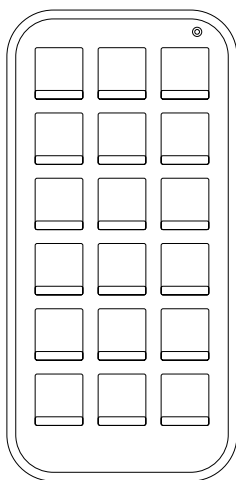

(緑)

(オレンジ)

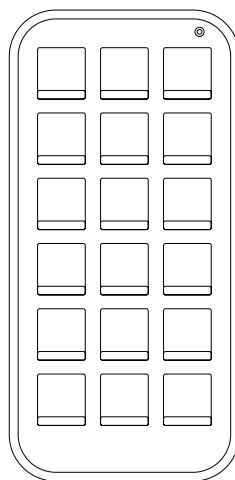

(緑)

(オレンジ)

E

↓
多くの拡張用
端末ご利用の場合

5. SMARTBOXをKEYCAFEアカウントにリンクする



スキャンして動画を見る

keycafe.com/ml/add_smartbox

6. SMARTBOXの作動確認



スキャンして動画を見る

keycafe.com/ml/test_smartbox



Visit our Help Centre:
Visitez notre Centre d'Aide:
Keycafeヘルプセンター:
support.keycafe.com

Talk to us on live chat:
Parlez-nous sur le chat en direct:
Keycafeカスタマーサポート:
keycafe.com/help